

Technical description

Atlas & Calibra models



Thermia AB is not liable or bound by warranty if these instructions are not adhered to during installation or service.

The English language is used for the original instructions.
Other languages are a translation of the original instructions.
(Directive 2006/42/EC)

© Copyright Thermia AB

Table of Contents

1	Transportation, space requirement and Recommended location	4
1.1	Transportation	4
1.2	Space requirement and recommended location	5
2	Heat pump data, dimensions and connections	7
2.1	Atlas and Calibra models	7
2.2	Atlas Duo and Calibra Duo models	8
3	Envelope	9
3.1	Envelope	9
4	Calibra 7 400V & 230V	10
4.1	Technical data, Calibra and Calibra Cool 7	10
4.2	Estimated flow and pressure for brine, Calibra 7, Calibra Cool and Calibra Duo 7	11
4.3	Estimated flow and pressure for heating circuit, Calibra , Calibra Cool 7 and Calibra Duo 7	12
4.4	Supply line temp 35°C and 55°C for Calibra 7, Calibra Cool and Calibra Duo 7	14
5	Calibra 12 400V & 230V	16
5.1	Technical data, Calibra 12	16
5.2	Estimated flow and pressure for brine, Calibra 12 and Calibra Duo 12	17
5.3	Estimated flow and pressure for heating circuit, Calibra 12 and Calibra Duo 12	18
5.4	Supply line temp 35° and 55°C for Calibra12 and Calibra Duo 12	20
6	Calibra Eco 8 230V & 400V	22
6.1	Technical data, Calibra Eco 8	22
6.2	Estimated flow and pressure for brine, Calibra Eco 8	24
6.3	Estimated flow and pressure for heating circuit, Calibra Eco 8	25
6.4	Supply line temp 35°C and 55°C for Calibra Eco 8	26
7	Calibra Eco 12 230V & 400V	28
7.1	Technical data, Calibra Eco 12	28
7.2	Estimated flow and pressure for brine, Calibra Eco 12 and Calibra Eco Duo 12	30
7.3	Estimated flow and pressure for heating circuit, Calibra Eco 12 and Calibra Eco Duo 12	30
7.4	Supply line temp 35° and 55°C for Calibra Eco12 and Calibra Eco Duo 12	32
8	Calibra Eco 16 400V	34
8.1	Technical data, Calibra Eco 16	34
8.2	Estimated flow and pressure for brine for Calibra Eco 16	35
8.3	Estimated flow and pressure for heating circuit, Calibra Eco 16	36
8.4	Supply line temp 35° and 55°C for Calibra Eco 16 and Calibra Eco Duo 16	37
9	Atlas 12 400V & 230V	39
9.1	Technical data, Atlas 12	39
9.2	Estimated flow and pressure for brine for Atlas 12	40
9.3	Estimated flow and pressure for heating circuit, Atlas 12	41
9.4	Supply line temp 35° and 55°C for Atlas 12 and Atlas Duo 12	43
10	Atlas 18 400V	45
10.1	Technical data, Atlas 18	45
10.2	Estimated flow and pressure for brine for Atlas 18	46
10.3	Estimated flow and pressure for heating circuit, Atlas 18	47
10.4	Supply line temp 35° and 55°C for Atlas 18 and Atlas Duo 18	48

Technical description Atlas & Calibra models

1 Transportation, space requirement and Recommended location

1.1 Transportation

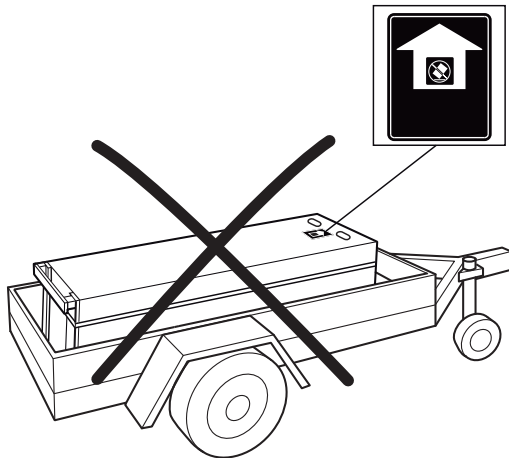

The heat pump must not be transported lying down!

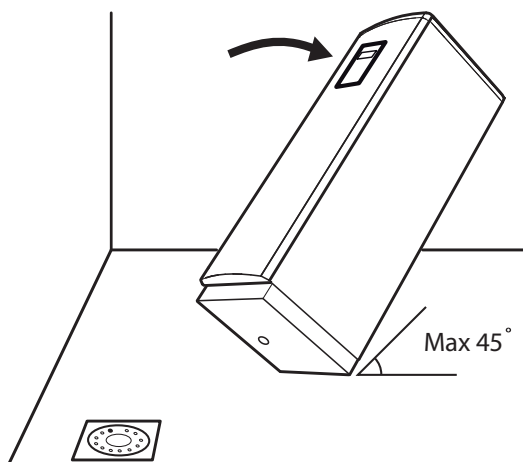

Maximum tilt 45 °

Atlas & Calibra models

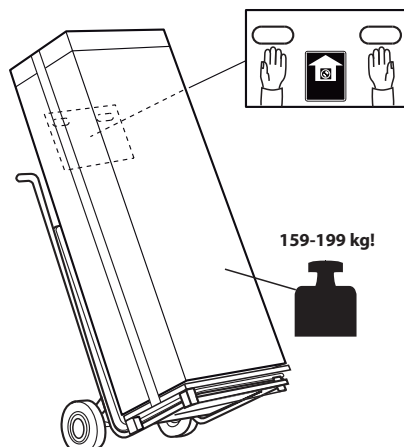

Atlas Duo & Calibra Duo models

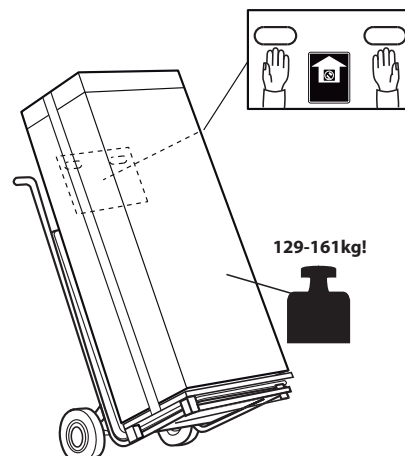

1.2 Space requirement and recommended location

Avoid placing the heat pump in a corner or near a bedroom. The surrounding walls can amplify the sound from the heat pump.

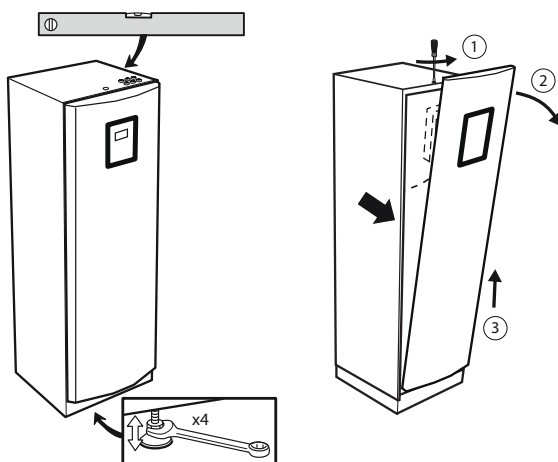
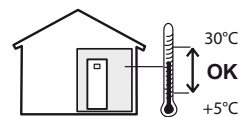
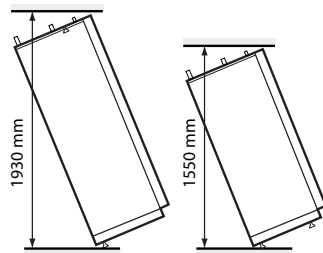
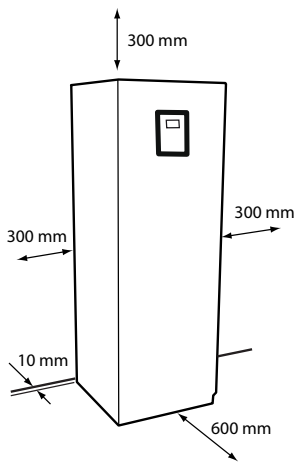
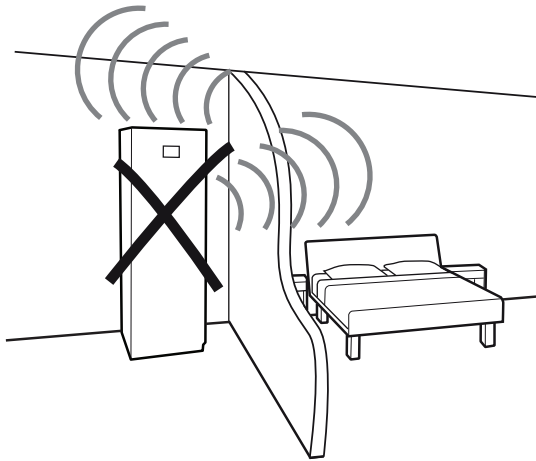

Adjust the heat pump using the adjustable feet so that it is horizontal on the ground.

The appliance shall be stored and installed so as to prevent mechanical damage from occurring.

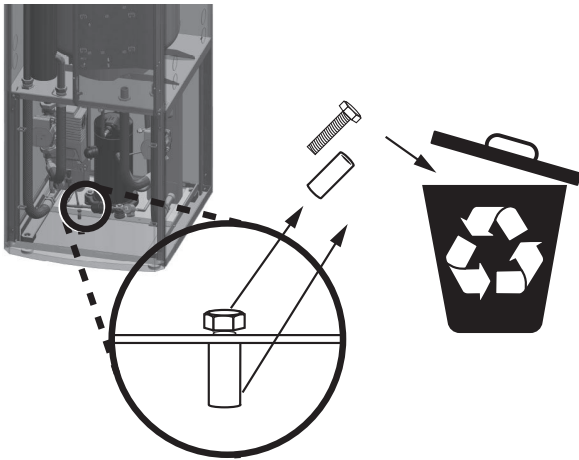

When the heat pump is in position, remove the transport safety. (If the heat pump should be moved further, put back the transport safety screw.) Make sure all parts of the transport safety is removed!

The heat pump should be placed on a stable floor with a floor well (so any condensation may drain from the condensation hole in the bottom of the heat pump), preferably a concrete floor. When placed on a wooden floor, the floor should be reinforced to hold the weight of the heat pump, including a filled water heater. Consider that condensation water may drip from the drain hole, so take the necessary steps to protect the floor.

2 Heat pump data, dimensions and connections

2.1 Atlas and Calibra models

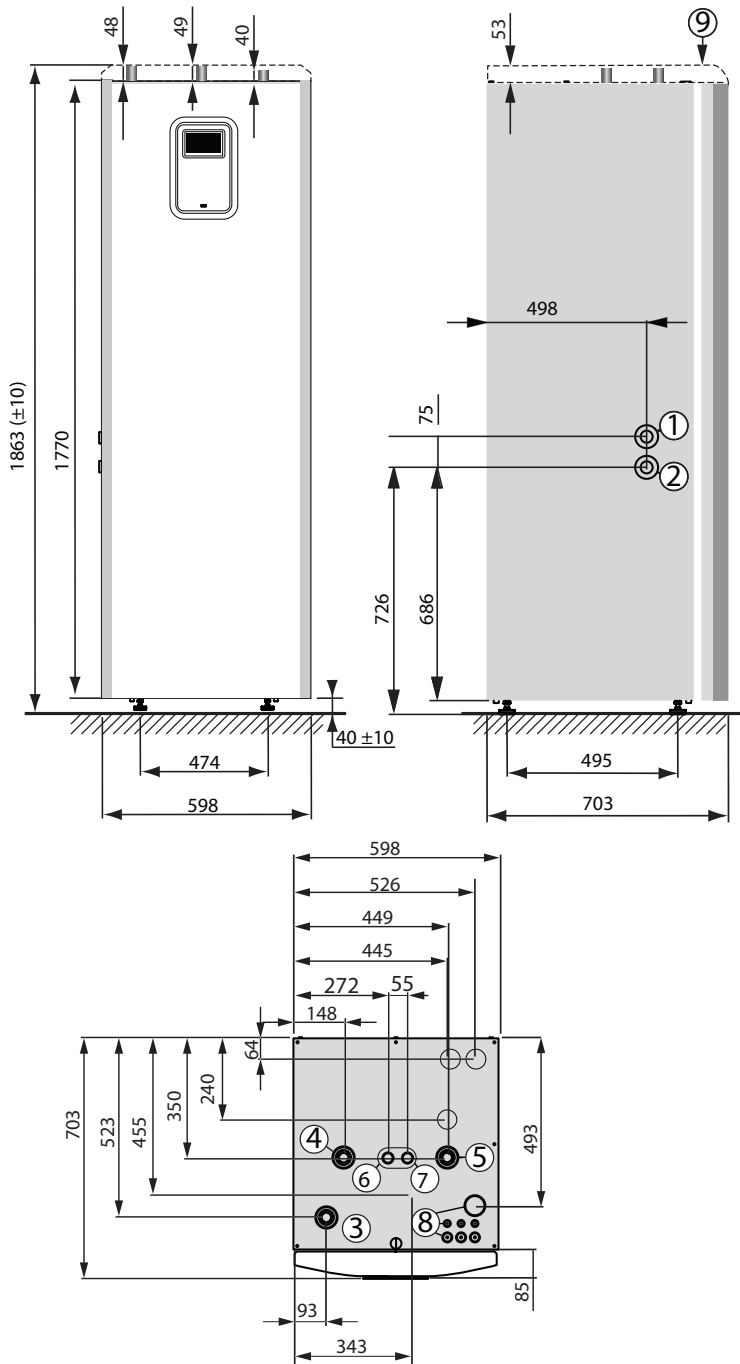

- 1 Brine in, 28 mm (left or right)
- 2 Brine out, 28 mm (left or right)
- 3 Heating system supply, 28 mm
- 4 Heating system return, 28 mm
- 5 Connection for bleed valve, 28 mm
- 6 Hot water line, 22 mm
- 7 Cold water line, 22 mm
- 8 Lead-in for power supply, sensor and communication cables
- 9 Top hood, Atlas (accessory for Calibra models)

The brine lines (1) and (2) can be connected on either the left or right-hand sides or to the two knock out holes on the top.

2.2 Atlas Duo and Calibra Duo models

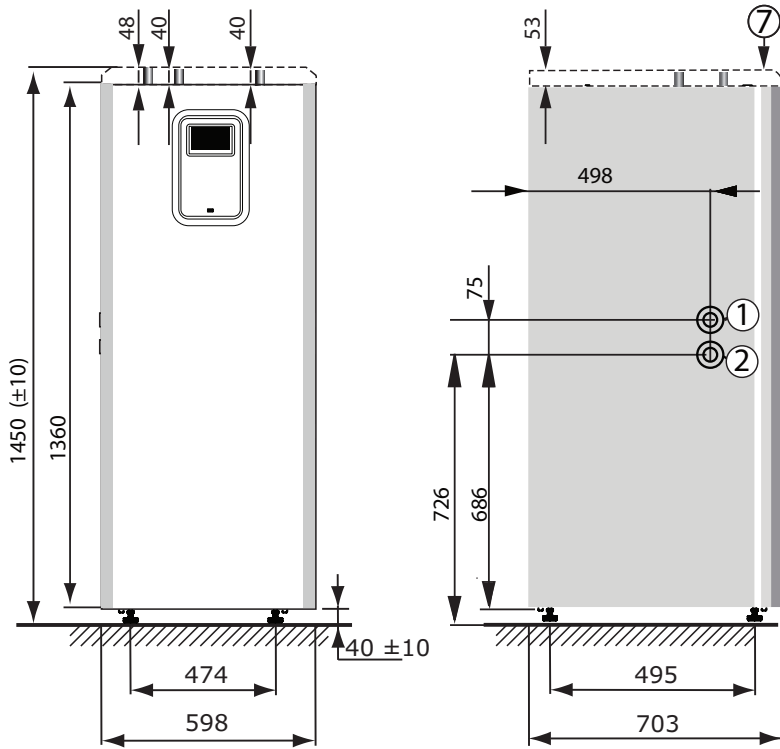

- 1 Brine in, 28 mm (left or right)
- 2 Brine out, 28 mm (left or right)
- 3 Heating system supply, 28 mm
- 4 Heating system and hot water tank return, 28 mm
- 5 Heating supply to hot water tank, 28 mm
- 6 Lead-in for power supply, sensor and communication cables
- 7 Top hood, Atlas (accessory for Calibra models)

The brine lines (1) and (2) can be connected on either the left or right-hand side or to the two knock out holes on the top.

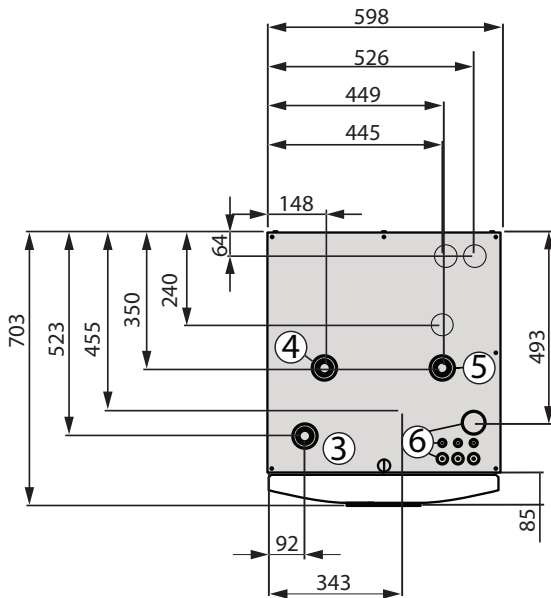

3 Envelope

3.1 Envelope

Pictures showing large envelope, actual working envelopes maybe smaller on certain compressor speeds.

Calibra 7
Calibra Cool 7
Calibra 12
Atlas 12

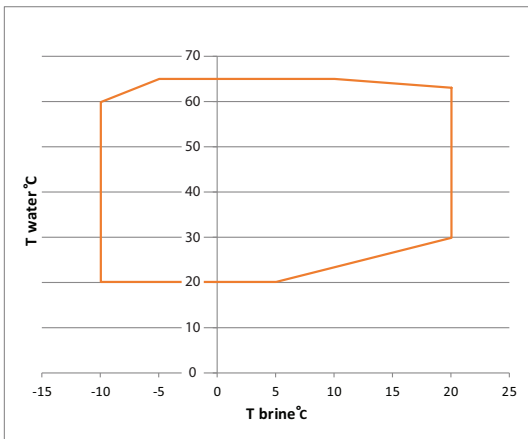

Calibra Eco 12

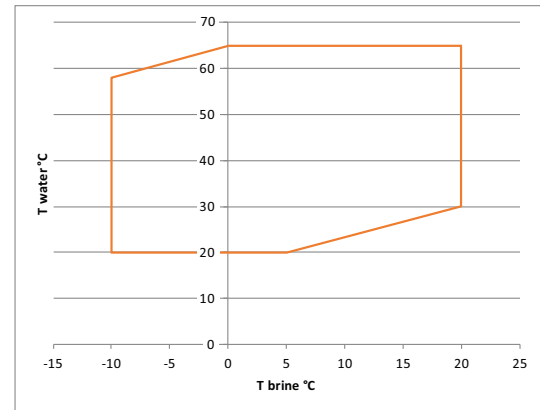

Calibra Eco 8

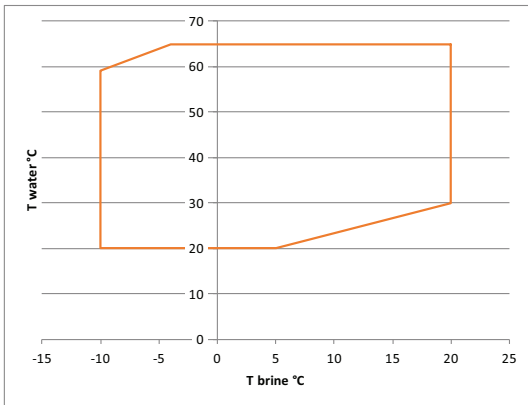

Calibra Eco 16

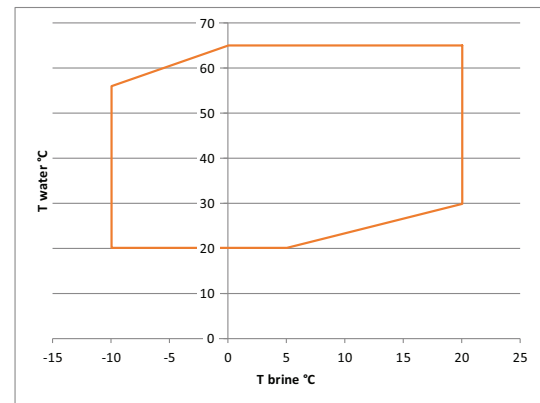

Atlas 18

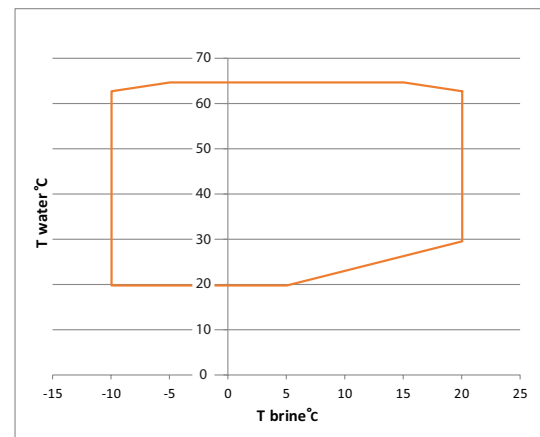

Technical description Atlas & Calibra models

4 Calibra 7 400V & 230V

4.1 Technical data, Calibra and Calibra Cool 7

Calibra 7 400V and 230V model		Unit	1,5-7 kW
Refrigerant	Type		R410A
	Amount ¹	kg	0,95
	CO ² equivalent	tons	1,983
	Design pressure	Bar (g)	45
Compressor	Type		Scroll
	Oil		POE
Electrical data, 400V model 3N~ Calibra, Calibra Cool	Mains power supply	Volt	400 3N~
	Max working power, compressor	kW	2,63
	Rated power, circulation pumps	kW	0,12
	Immersion heater, 3 steps	kW	2/4/6
	Fuses, combined ²	A	(13)/13/13/16
Electrical data, 230V model 3~ Calibra	Mains power supply	Volt	230 3~
	Max working power, compressor	kW	2,63
	Rated power, circulation pumps	kW	0,12
	Immersion heater, 3 steps	kW	2/4/6
	Fuses, combined ²	A	20/25/32
	Fuse separate supply (compressor only)	A	13
	Fuse separate supply, Immersion heater only	A	10/16/25
Electrical data, 230V model 1N~ Calibra	Mains power supply	Volt	230 1N~
	Max working power, compressor	kW	2,63
	Rated power, circulation pumps	kW	0,12
	Immersion heater, 3 steps	kW	2/4/6
	Fuses, combined ²	A	25/32/40
	Fuse separate supply (compressor only)	A	13
	Fuse separate supply, Immersion heater only	A	10/20/32
Performance	SCOP, floor heating (35°C) ³		5,77
	SCOP, radiator heating (55°C) ³		4,12
	COP ⁴		4,65
Energy class-system ⁵	Floor heating (35°C)		A+++
	Radiator heating (55°C)		A+++
Energy class-product ⁶	Floor heating (35°C)		A+++
	Radiator heating (55°C)		A+++
	Hot water (Economy) ⁷		A
	Hot water (Normal/Comfort) ⁸		A
Min/Max temperature	Brine	°C	20/-10
	Heating	°C	65/20
Anti freeze type 9	Ethanol + water solution -17°C ± 2		
Pressure limits refrigerant circuit	Low pressure	bar(g)	2,3
	Operating pressure	bar(g)	41,5
	High pressure	bar(g)	45,0

Sound power level	Calibra, Calibra Cool	dB(A)	28-42 ¹⁰ (32) ¹¹
	Calibra Duo	dB(A)	32-33 ¹⁰ (34) ¹¹
Hot water performance	Volume 40°C hot water ¹²	l	260
	COP, hot water ⁷		2,7
	Hot water including HGW ¹³	l	n/a
Hot water tank, size	Calibra, Calibra Cool	l	184
	Calibra Duo	l	Optional
Water mains		bar(g)	10 Max
Weight	Calibra, Calibra Cool empty	kg	150
	Calibra, Calibra Cool filled	kg	340
	Calibra Duo	kg	115
Dimensions (WxDxH)	Calibra, Calibra Cool	mm	598x703x1863 +/-10
	Calibra Duo	mm	598x703x1450 +/-10

1) The refrigerant circuit is hermetically sealed and contains refrigerants covered by the F-gas regulation. GWP for R410A according to EC 517/2014 is 2088, which gives a CO2 equivalent corresponding to Calibra: 1,983 tons.

2) The minimum recommended fuse size depends on the limitation of the electrical immersion heater in combination with the compressor. The maximum permissible power for immersion heater can also be set differently with and without compressor for further adjustment at low fuses. Control and circulation pumps are operated with L1. Calibra 7 complies with IEC 61000-3-12 without conditional connection. 230V versions: The feeding for immersion heater and compressor can be physically separated.

3) SCOP according to EN14825, Cold climate (Helsinki), P-design Calibra 7: 6 kW (B0W55), 7 kW (B0W35). P-design .

4) At B0 / W35, according to EN14511

5) When the heat pump is installed in a heating system that is controlled via the heat pump's control computer. According to EU regulation 811/2013.

6) When the heat pump is not connected to a heating system, and the function of the built-in control computer is not taken into account. According to EU regulation 811/2013.

7) Hot water performance according to EN16147, COP according to XL cycle with the control computer set for Economy mode and built-in hot water tank.

8) Hot water performance according to EN16147, COP according to XL cycle with the control computer set for Normal / Comfort mode and built-in processor.

9) Local regulations and regulations must always be checked before antifreeze agents are used.

10) Sound power level measured according to EN12102 and EN 3741 (min / max B0W35).

11) Sound power level according to energy labeling, measured according to EN12102 and EN3741 (B0W55).

12) Hot water performance according to EN16147, V40 according to XL cycle with the control computer set for comfort mode and built-in hot water tank.

13) Maximum available amount of hot water when the boiler has been able to fully charge using HGW operation and subsequent V40 discharge in accordance with EN16147

4.2 Estimated flow and pressure for brine, Calibra 7, Calibra Cool and Calibra Duo 7

Flow brine and external available pressure B0W35 (Δt 3)

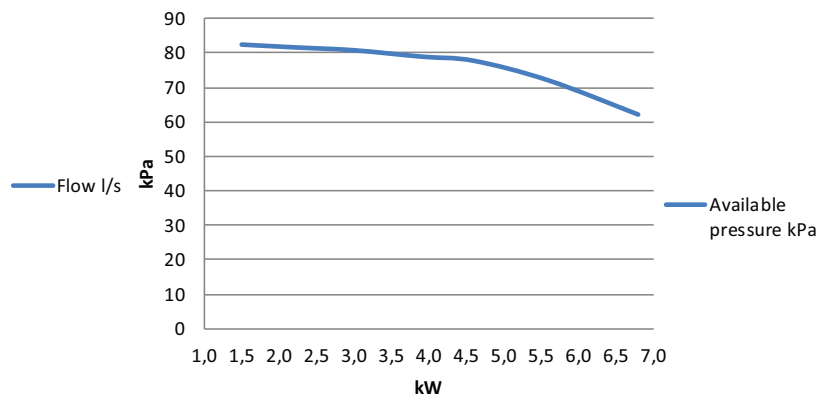
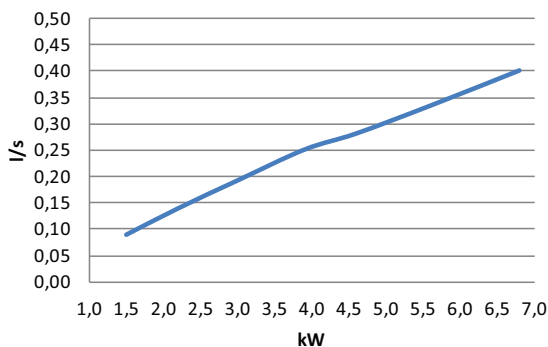

Flow brine and external available pressure B0W55 (Δt 3)

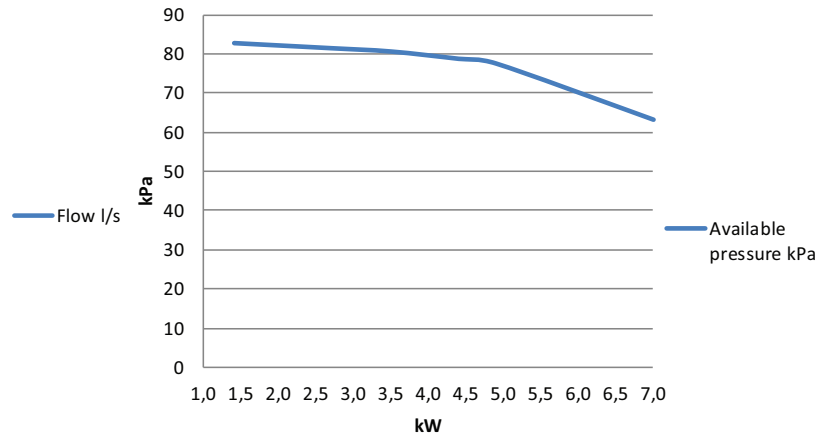
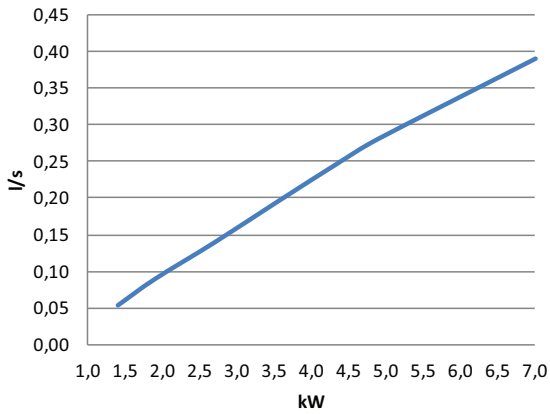

4.3 Estimated flow and pressure for heating circuit, Calibra , Calibra Cool 7 and Calibra Duo 7

Flow heating circuit and external available pressure B0W35 (Δt 5)

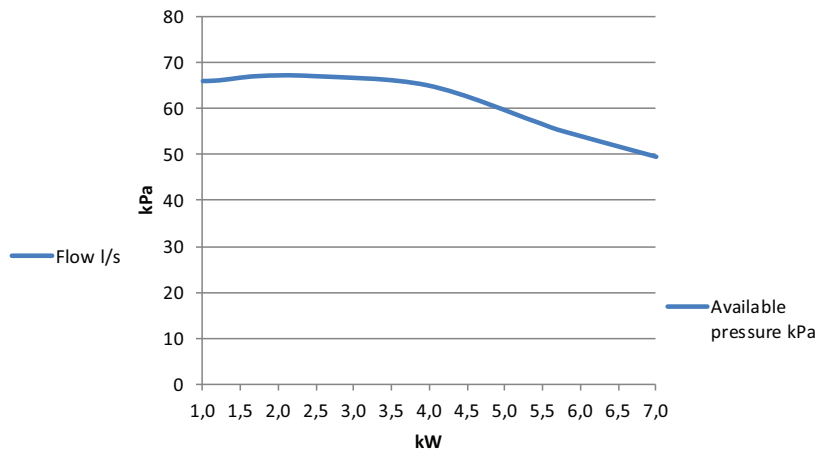
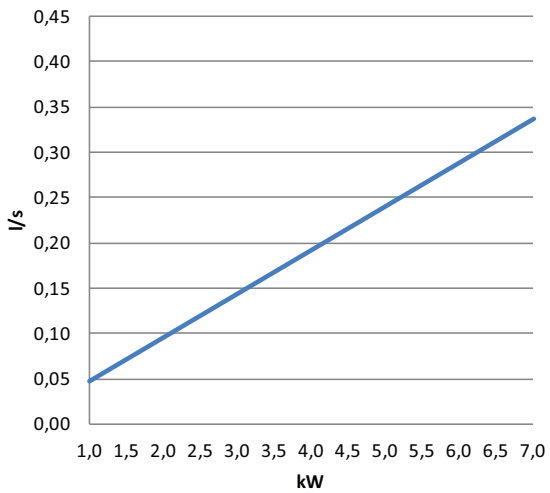

Flow heating circuit and external available pressure BOW55 (Δt 8)

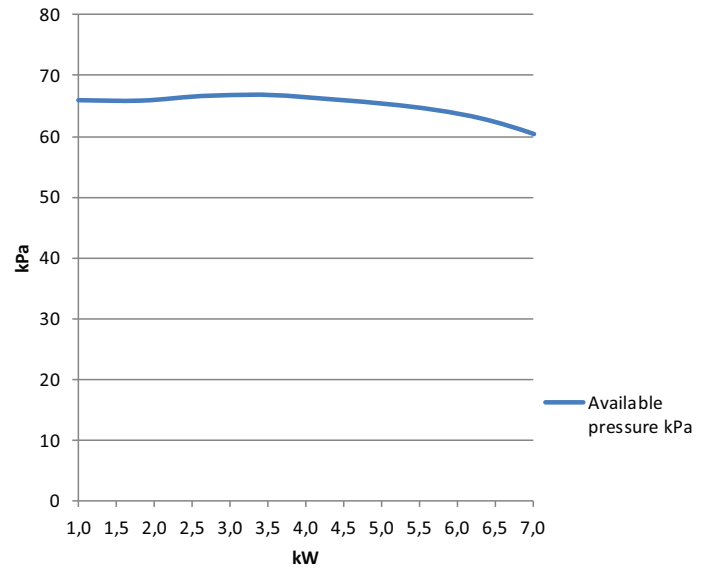
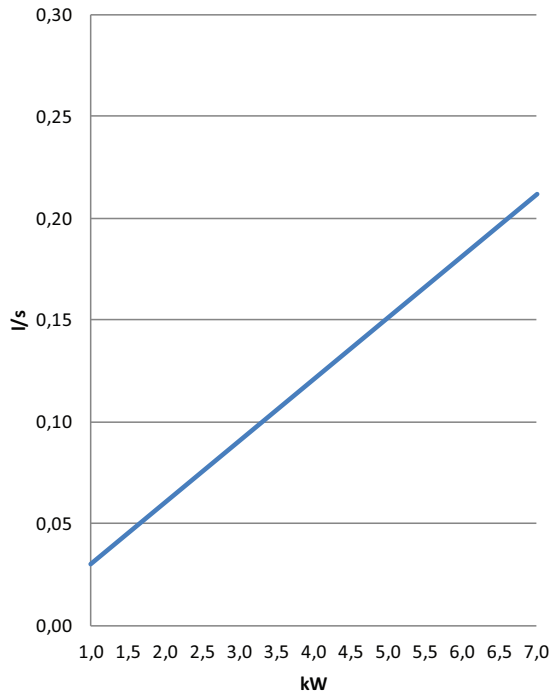

Technical description Atlas & Calibra models

4.4 Supply line temp 35°C and 55°C for Calibra 7, Calibra Cool and Calibra Duo 7

Heating capacity with a desired supply line temperature at 35°C at different compressor speed and brine temperature.

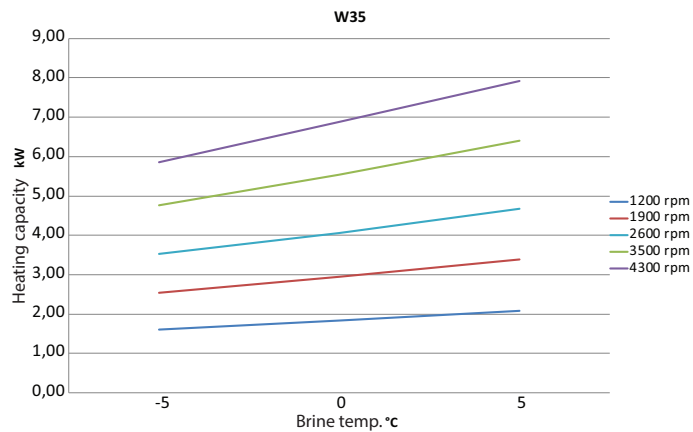

RPM	Brine temp.	-5	0	+5
1200	Heating capacity (kW)	1,6	1,8	2,1
	Input power (kW)	0,5	0,5	0,5
	COP	3,1	3,7	4,4
1900	Heating capacity (kW)	2,6	2,9	3,4
	Input power (kW)	0,7	0,7	0,7
	COP	3,8	4,4	5,2
2600	Heating capacity (kW)	3,5	4,1	4,7
	Input power (kW)	0,9	0,9	0,9
	COP	4,0	4,6	5,3
3500	Heating capacity (kW)	4,8	5,5	6,4
	Input power (kW)	1,2	1,2	1,2
	COP	3,9	4,5	5,2
4300	Heating capacity (kW)	5,9	7,1	7,9
	Input power (kW)	1,6	1,6	1,6
	COP	3,7	4,3	4,9

Technical description Atlas & Calibra models

Heating capacity with a desired supply line temperature at 55°C at different compressor speed and brine temperature.

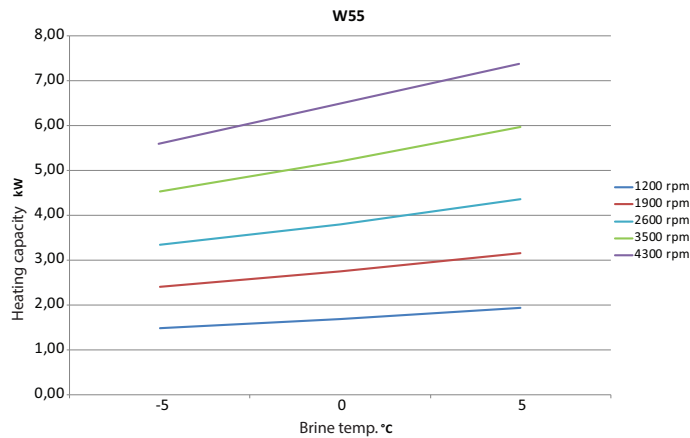

RPM	Brine temp.	-5	0	+5
1200	Heating capacity (kW)	1,5	1,7	1,9
	Input power (kW)	0,8	0,8	0,8
	COP	2,0	2,2	2,5
1900	Heating capacity (kW)	2,4	2,8	3,2
	Input power (kW)	1,0	1,0	1,0
	COP	2,4	2,7	3,1
2600	Heating capacity (kW)	3,4	3,8	4,4
	Input power (kW)	1,3	1,3	1,4
	COP	2,6	2,9	3,2
3500	Heating capacity (kW)	4,5	5,2	6,0
	Input power (kW)	1,8	1,8	1,8
	COP	2,6	2,9	3,3
4300	Heating capacity (kW)	5,6	6,5	7,4
	Input power (kW)	2,2	2,3	2,3
	COP	2,5	2,8	3,2

5 Calibra 12 400V & 230V

5.1 Technical data, Calibra 12

Calibra 12 400V and 230V		Unit	3-12 kW
Refrigerant	Type		R410A
	Amount ¹	kg	1,40
	CO ² equivalent	tons	2,923
	Design pressure	Bar (g)	45
Compressor	Type		Scroll
	Oil		POE
Electrical data, 400V, 3N~	Mains power supply	Volt	400 3N~
	Max working power, compressor	kW	4,3
	Rated power, circulation pumps	kW	0,2
	Immersion heater, 3 steps	kW	3/6/9
	Fuses, combined ²	A	(10)/13/20/25
Electrical data, 230V, 3~	Mains power supply	Volt	230 3~
	Max working power, compressor	kW	4,3
	Rated power, circulation pumps	kW	0,2
	Immersion heater, 3 steps	kW	3/5/8
	Fuses, combined ²	A	32/32/40
	Fuse separate supply (compressor only)	A	25
	Fuse separate supply, Immersion heater only	A	13/20/32
Electrical data, 230V, 1N~	Mains power supply	Volt	230 1N~
	Max working power, compressor	kW	4,3
	Rated power, circulation pumps	kW	0,2
	Immersion heater, 3 steps	kW	3/5/8
	Fuses, combined ²	A	25/32/40
	Fuse separate supply (compressor only)	A	25
	Fuse separate supply, Immersion heater only	A	16/25/40
Performance	SCOP, floor heating (35°C) ³		5,8
	SCOP, radiator heating (55°C) ³		4,29
	COP ⁴		4,75
Energy class-system ⁵	Floor heating (35°C)		A+++
	Radiator heating (55°C)		A+++
Energy class-product ⁶	Floor heating (35°C)		A+++
	Radiator heating (55°C)		A+++
	Hot water (Economy) ⁷		A
	Hot water (Normal/Comfort) ⁸		A
Min/Max temperature	Brine	°C	20/-10
	Heating	°C	65/20
Anti freeze type ⁹	Ethanol + water solution -17°C ± 2		
Pressure limits refrigerant circuit	Low pressure	bar(g)	2,3
	Operating pressure	bar(g)	41,5
	High pressure	bar(g)	45,0

Sound power level	Calibra	dB(A)	29-46 ¹⁰ (35) ¹¹
	Calibra Duo	dB(A)	30-48 ¹⁰ (36) ¹¹
Hot water performance	Volume 40°C hot water ¹²	l	260
	COP, hot water ⁷		2,7
	Hot water including HGW ¹³	l	n/a
Hot water tank, size	Calibra	l	184
	Calibra Duo	l	Optional
Water mains		bar(g)	Max 10
Weight	Calibra, empty	kg	162
	Calibra, filled	kg	352
	Calibra Duo	kg	127
Dimensions (WxDxH)	Calibra	mm	598x703x1863 +/-10
	Calibra Duo	mm	598x703x1450 +/-10

1) The refrigerant circuit is hermetically sealed and contains refrigerants covered by the F-gas regulation. GWP for R410A according to EC 517/2014 is 2088, which gives a CO2 equivalent corresponding to Calibra 12: 292,3 tons.

2) The minimum recommended fuse size depends on the limitation of the electrical immersion heater in combination with the compressor. The maximum permissible power for immersion heater can also be set differently with and without compressor for further adjustment at low fuses. 400V versions: The power supply and the frequency converter for the compressor are powered by L1, L2 and L3. Control and circulation pumps are operated with L1. Meets IEC61000-3-12 at Ssc connection point Calibra 12 <2.1 MVA without action 230V versions: The feeding for immersion heater and compressor can be physically separated.

3) SSCOP according to EN14825, Cold climate (Helsinki), P-design Calibra 12: 11 kW (B0W55), 12 kW (B0W35).

4) At B0 / W35, according to EN14511

5) When the heat pump is installed in a heating system that is controlled via the heat pump's control computer. According to EU regulation 811/2013.

6) When the heat pump is not connected to a heating system, and the function of the built-in control computer is not taken into account. According to EU regulation 811/2013.

7) Hot water performance according to EN16147, COP according to XL cycle with the control computer set for Economy mode and built-in hot water tank.

8) Hot water performance according to EN16147, COP according to XL cycle with the control computer set for Normal / Comfort mode and built-in processor.

9) Local regulations and regulations must always be checked before antifreeze agents are used.

10) Sound power level measured according to EN12102 and EN 3741 (min / max B0W35).

11) Sound power level according to energy labeling, measured according to EN12102 and EN3741 (B0W55).

12) Hot water performance according to EN16147, V40 according to XL cycle with the control computer set for comfort mode and built-in hot water tank.

13) Maximum available amount of hot water when the boiler has been able to fully charge using HGW operation and subsequent V40 discharge in accordance with EN16147

5.2 Estimated flow and pressure for brine, Calibra 12 and Calibra Duo 12

Flow brine and external available pressure B0W35 (Δt 3)

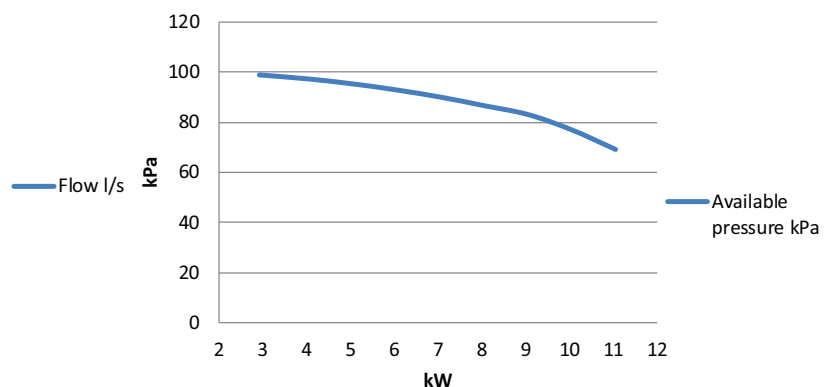
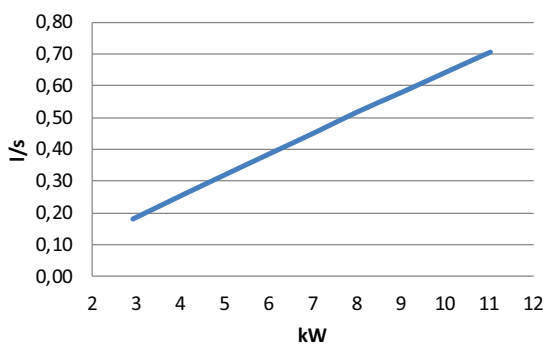

Flow brine and external available pressure B0W55 (Δt 3)

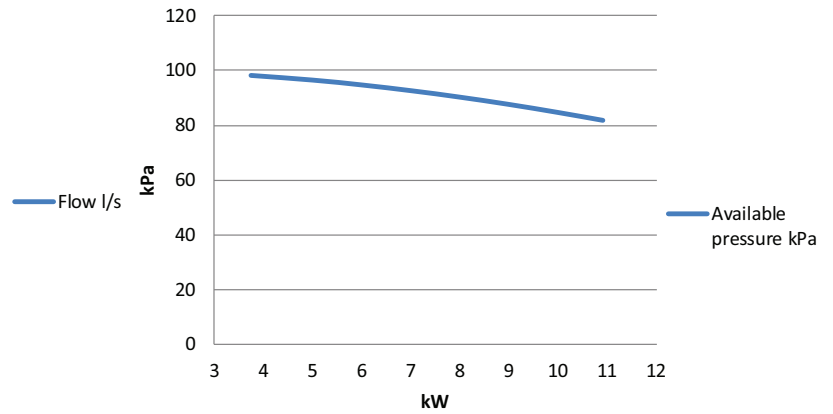
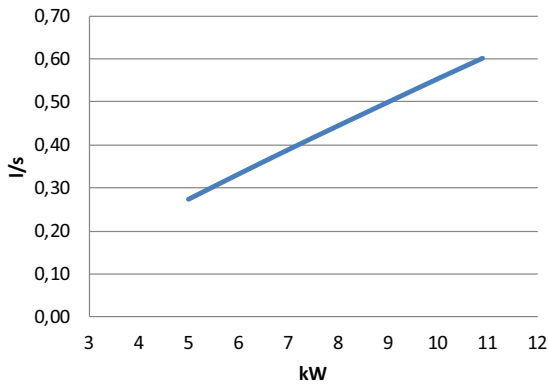

5.3 Estimated flow and pressure for heating circuit, Calibra 12 and Calibra Duo 12

Flow heating circuit and external available pressure B0W35 (Δt 5)

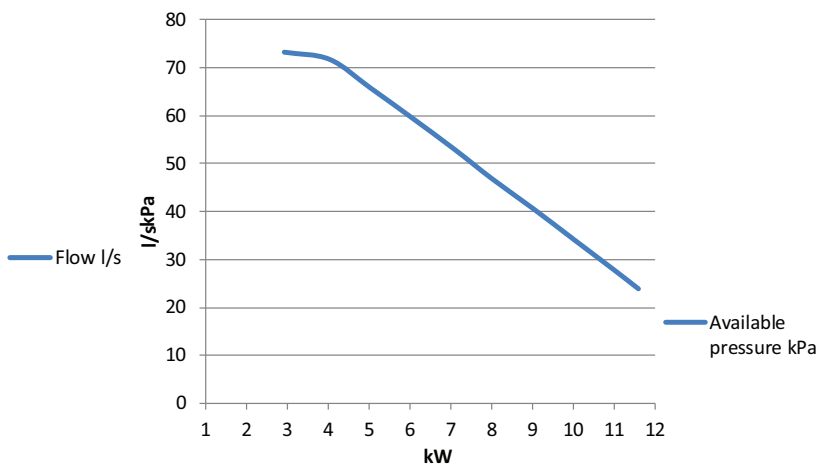
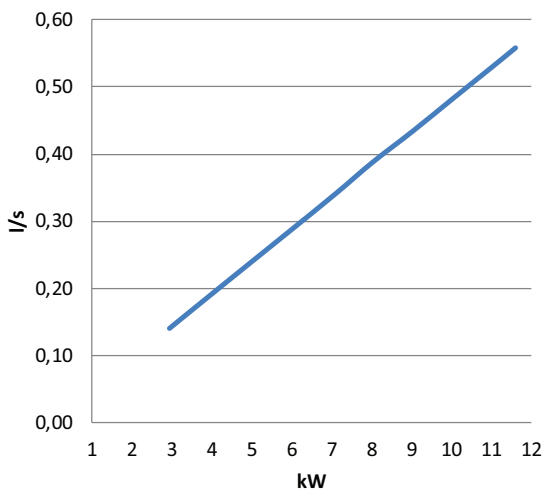

Flow heating circuit and external available pressure BOW55 (Δt 8)

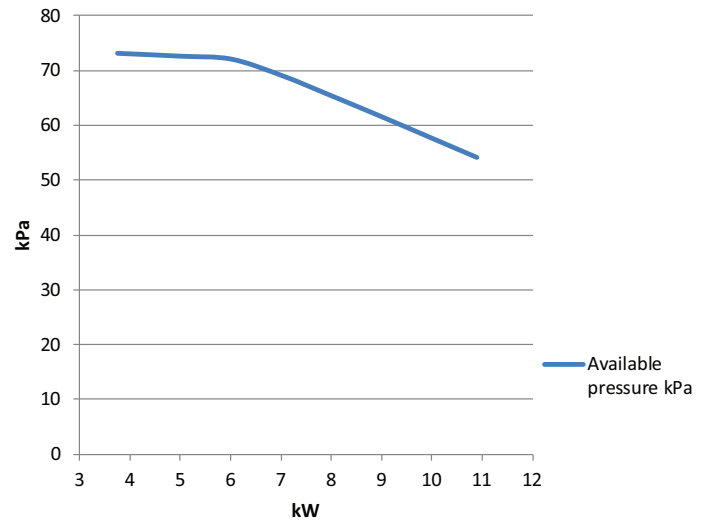
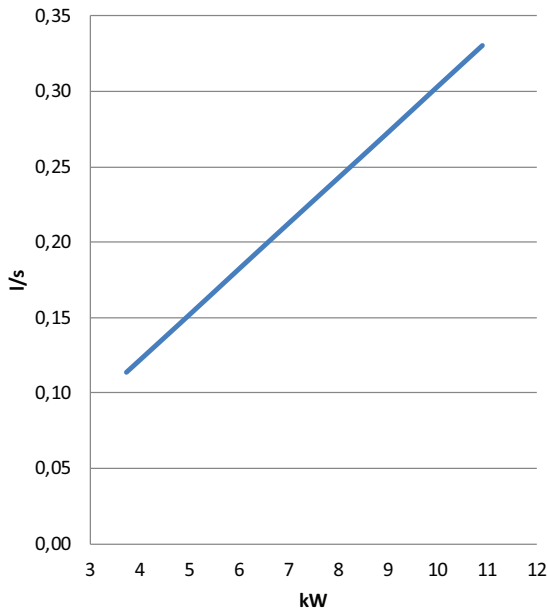

Technical description Atlas & Calibra models

5.4 Supply line temp 35° and 55°C for Calibra12 and Calibra Duo 12

Heating capacity with a desired supply line temperature at 35°C at different compressor speed and brine temperature. At higher brine temperatures max compressor speed may be automatically reduced to below 5300 max RPM

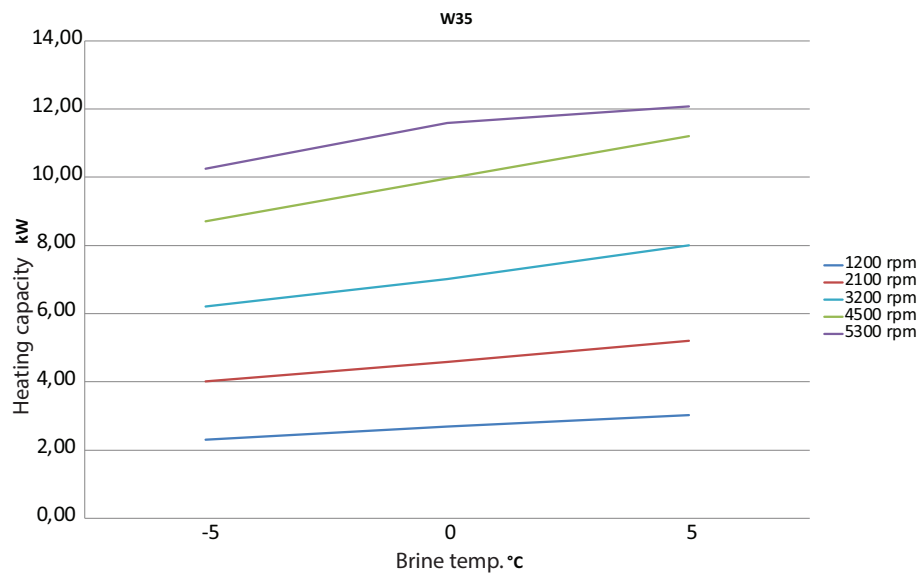

RPM	Brine temp.	-5	0	+5
1200	Heating capacity (kW)	2,3	2,7	3,0
	Input power (kW)	0,7	0,7	0,7
	COP	3,5	4,1	4,6
2100	Heating capacity (kW)	4,0	4,6	5,2
	Input power (kW)	1,0	1,0	1,0
	COP	4,0	4,6	5,3
3200	Heating capacity (kW)	6,2	7,0	8,0
	Input power (kW)	1,5	1,5	1,5
	COP	4,1	4,7	5,3
4500	Heating capacity (kW)	8,7	10,0	11,2
	Input power (kW)	2,2	2,2	2,2
	COP	4,0	4,6	5,2
5300	Heating capacity (kW)	10,2	11,6	12,1
	Input power (kW)	2,6	2,7	2,7
	COP	3,9	4,4	4,6

Technical description Atlas & Calibra models

Heating capacity with a desired supply line temperature at 55°C at different compressor speed and brine temperature. At higher brine temperatures max compressor speed may be automatically reduced to below 5300 max RPM

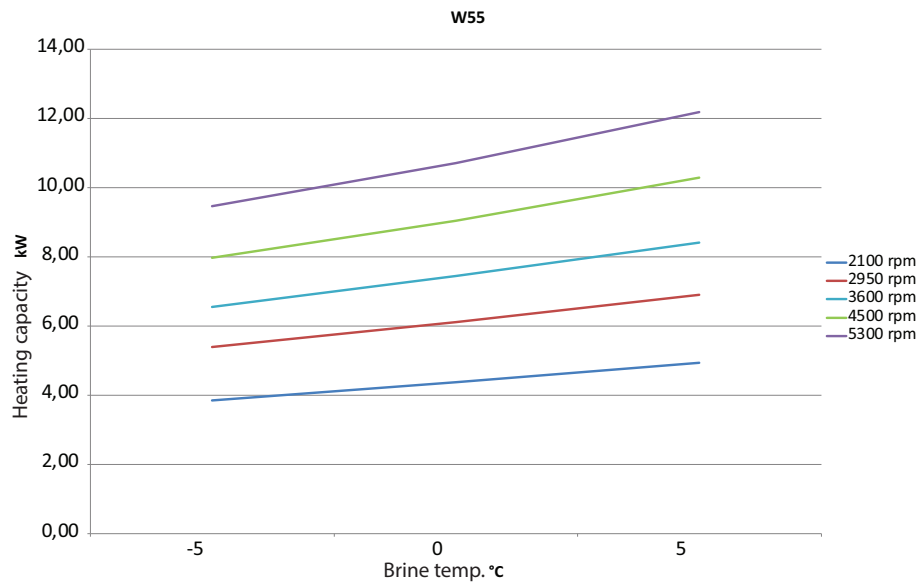

RPM	Brine temp.	-5	0	+5
2100	Heating capacity (kW)	3,9	4,4	4,9
	Input power (kW)	1,5	1,5	1,5
	COP	2,6	2,9	3,2
2950	Heating capacity (kW)	5,4	6,1	6,9
	Input power (kW)	2,0	2,0	2,1
	COP	2,7	3,0	3,4
3600	Heating capacity (kW)	6,6	7,5	8,4
	Input power (kW)	2,4	2,4	2,5
	COP	2,8	3,1	3,4
4500	Heating capacity (kW)	8,0	9,1	10,3
	Input power (kW)	3,0	3,1	3,1
	COP	2,7	3,0	3,3
5300	Heating capacity (kW)	9,5	10,7	12,2
	Input power (kW)	3,7	3,7	3,8
	COP	2,6	2,9	3,2

Technical description Atlas & Calibra models

6 Calibra Eco 8 230V & 400V

6.1 Technical data, Calibra Eco 8

Calibra Eco 8		Unit	2-8 kW
Refrigerant	Type		R452B
	Amount ¹	kg	0,90
	CO ² equivalent	tons	0,628
	Design pressure	Bar (g)	45
Compressor	Type		Scroll
	Oil		POE
Electrical data, 400V, 3N~	Mains power supply	Volt	400 3N~
	Max working power, compressor	kW	2,8
	Marking power, circulation pumps	kW	0,1
	Immersion heater, 3 steps	kW	(0)/2/4/6
	Fuses, combined ^{2A, 2B}	A	(13)/13/13/16 ^{2A}
	Fuse separate supply, compressor only	A	N/A
	Fuse separate supply, immersion heater only	A	N/A
Electrical data, 230V, 1N~	Mains power supply	Volt	230 1N~
	Max working power, compressor	kW	2,8
	Marking power, circulation pumps	kW	0,1
	Immersion heater, 3 steps	kW	(0)/2/4/6
	Fuses, combined ^{2C}	A	(13)/25/32/40 ^{2C}
	Fuse separate supply, compressor only	A	13
	Fuse separate supply, immersion heater only	A	10/20/32
Electrical data, 230V, 3~	Mains power supply	Volt	230 3~
	Max working power, compressor	kW	2,8
	Marking power, circulation pumps	kW	0,1
	Immersion heater, 3 steps	kW	(0)/2/4/6
	Fuses, combined ^{2C}	A	(13)/20/25/32 ^{2C}
	Fuse separate supply, compressor only	A	13
	Fuse separate supply, immersion heater only	A	10/16/25
Performance	SCOP, floor heating (35°C) ³		5,87
	SCOP, radiator heating (55°C) ³		4,10
	COP ⁴		4,6
Energy class-system ⁵	Floor heating (35°C)		A+++
	Radiator heating (55°C)		A+++
Energy class-product ⁶	Floor heating (35°C)		A+++
	Radiator heating (55°C)		A+++
	Hot water (Economy) ⁷		A+
	Hot water (Normal/Comfort) ⁸		A
Max/Min temperature	Brine	°C	20/-10
	Heating	°C	65/20
Max pressure	Brine	bar(g)	3
	Heating	bar(g)	3
Anti freeze type ⁹	Ethanol + water solution -17°C ± 2		

Technical description Atlas & Calibra models

Pressure limits refrigerant circuit	Low pressure	bar(g)	2,3
	Operating pressure	bar(g)	41,5
	High pressure	bar(g)	45,0
Sound power level	Calibra Eco	dB(A)	30-42 ¹⁰ (32) ¹¹
	Calibra Eco Duo	dB(A)	30-42 ¹⁰ (33) ¹¹
Hot water performance	Volume 40°C hot water ¹²	l	260
	COP, hot water ⁷		3,14
	Hot water including HGW ¹³	l	n/a
Hot water tank, size	Calibra Eco	l	184
	Calibra Eco Duo	l	optional
Water mains		bar(g)	9
Weight	Calibra Eco, empty	kg	150
	Calibra Eco, filled	kg	340
	Calibra Eco Duo	kg	115
Dimensions (WxDxH)	Calibra Eco	mm	598x703x1863 +/-10
	Calibra Eco Duo	mm	598x703x1450 +/-10

1) The refrigerant circuit is hermetically sealed and contains refrigerants covered by the F-gas regulation. GWP for R452B according to EC 517/2014 is 698.

2A) The minimum recommended fuse size depends on the limitation of the electrical immersion heater in combination with the compressor. The maximum permissible power for immersion heater can also be set differently with and without compressor for further adjustment at low fuses. Control and circulation pumps are operated with L1. Immersion heater is powered by L1 and L2, frequency converter for the compressor is powered by L3. Complies with IEC 61000-3-12 without conditional connection. 230V versions: The feeding for immersion heater and compressor can be physically separated.

2B) The minimum recommended fuse size depends on the limitation of the electrical immersion heater in combination with the compressor. The maximum permissible power for immersion heater can also be set differently with and without compressor for further adjustment at low fuses. Control and circulation pumps are operated with L1. 400V versions: The power supply and the frequency converter for the compressor are powered by L1, L2 and L3. Meets IEC61000-3-12 at Ssc connection point Calibra Eco 12 <1.3 MVA, Calibra Eco 16 <1.8 MVA without action. Calibra Eco 12 230V: The feeding for immersion heater and compressor can be physically separated. Complies with IEC 61000-3-12 without conditional connection.

2C) The minimum recommended fuse size depends on the limitation of the electrical immersion heater in combination with the compressor. The maximum permissible power for immersion heater can also be set differently with and without compressor for further adjustment at low fuses. Connection of the 230V version can be done to single phase or 3 phase 230V grids, either with one common supply, or with physically separated supplies to heat pump (compressor) and to immersion heater to lower the fuse needed. Complies with IEC 61000-3-12 without conditional connection.

3) SCOP according to EN14825, cold climate (Helsinki), P-design Calibra Eco 8: 6,2 kW (B0W55), 6,7 kW (B0W35). P-design Calibra Eco 12: 10,6 kW (B0W55), 11,5 kW (B0W35). P-design Calibra Eco 16: 14,7 kW (B0W55), 15,9 kW (B0W35)

4) At B0/W35, according to EN14511

5) When the heat pump is installed in a heating system that is controlled via the heat pump's control computer. According to EU regulation 811/2013.

6) When the heat pump is not connected to a heating system, and the function of the built-in control computer is not taken into account. According to EU regulation 811/2013.

7) Hot water performance according to EN16147, COP according to XL cycle with the control computer set for Economy mode and built-in hot water tank.

8) Hot water performance according to EN16147, COP according to XL cycle with the control computer set for Normal / Comfort mode and built-in processor.

9) Local regulations and regulations must always be checked before antifreeze agents are used.

10) Sound power level measured according to EN12102 and EN 3741 (min / max B0W35).

11) Sound power level according to energy labeling, measured according to EN12102 and EN3741 (B0W55).

12) Hot water performance according to EN16147, V40 according to XL cycle with the control computer set for comfort mode and built-in hot water tank.

6.2 Estimated flow and pressure for brine, Calibra Eco 8

Flow brine and external available pressure B0W35 (Δt 3)

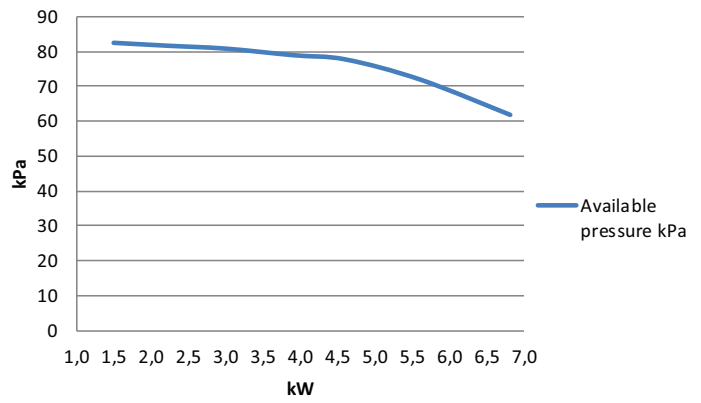
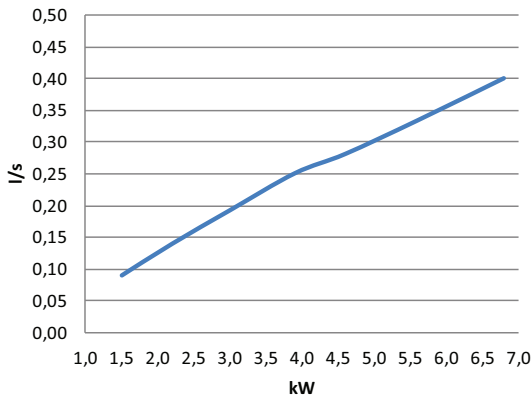

Flow brine and external available pressure B0W55 (Δt 3)

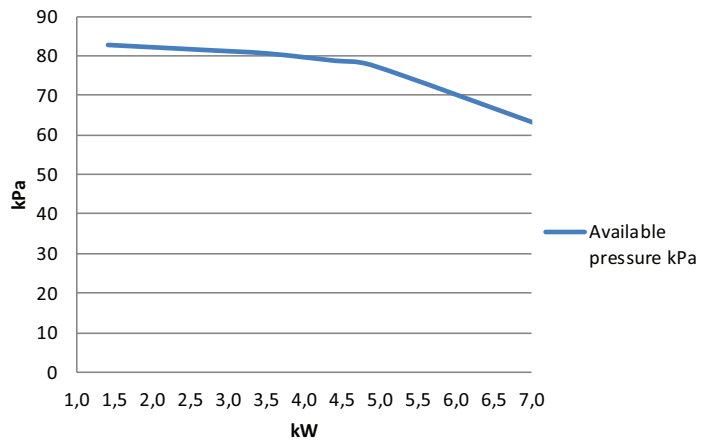
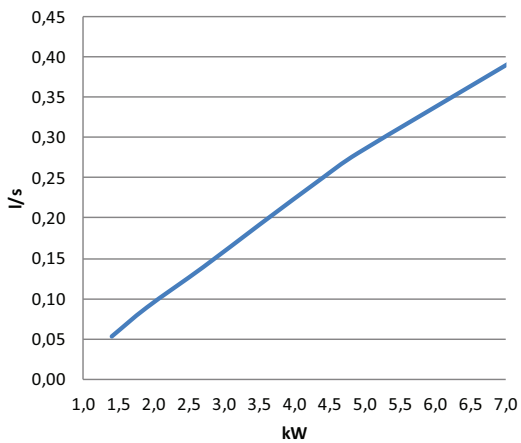

6.3 Estimated flow and pressure for heating circuit, Calibra Eco 8

Flow heating circuit and external available pressure B0W35 (Δt 5)

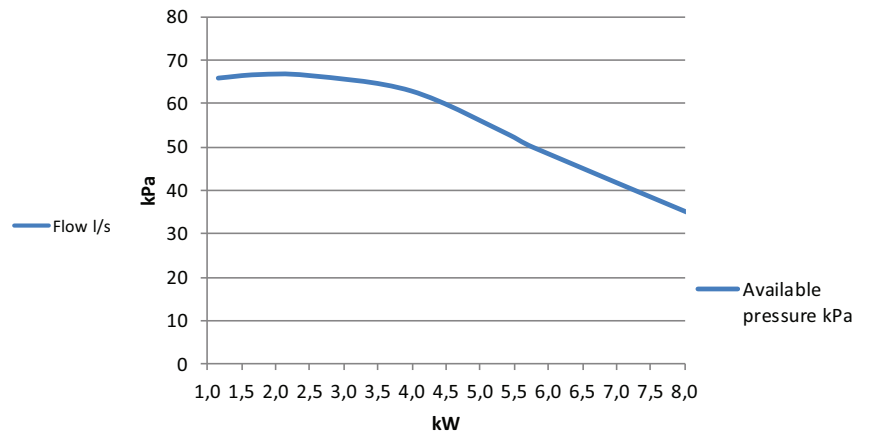
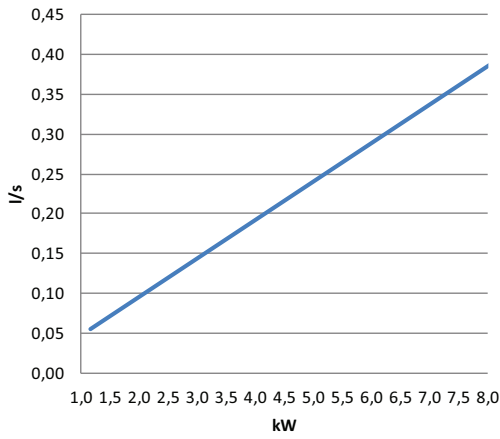

Flow heating circuit and external available pressure B0W55 (Δt 8)

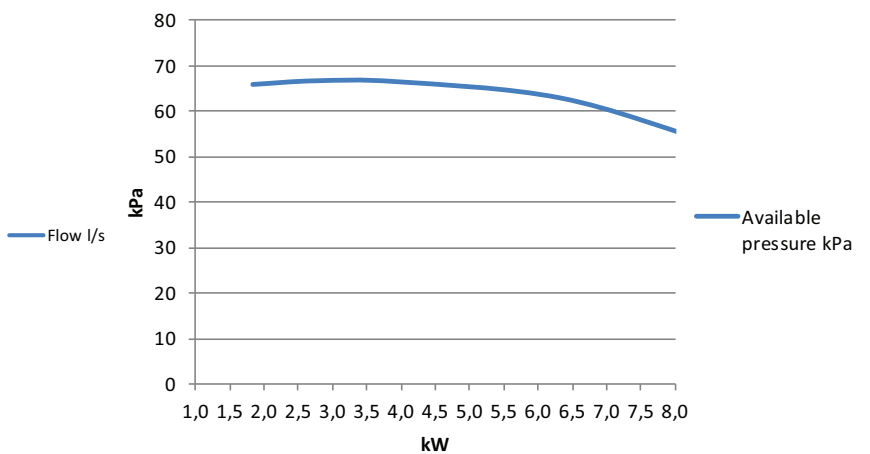
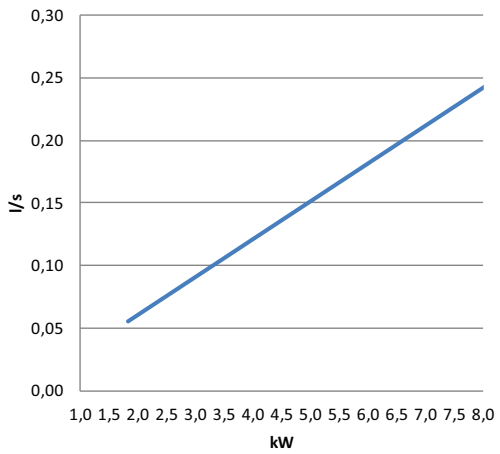

Technical description Atlas & Calibra models

6.4 Supply line temp 35°C and 55°C for Calibra Eco 8

Heating capacity with a desired supply line temperature at 35°C at different compressor speed and brine temperature.

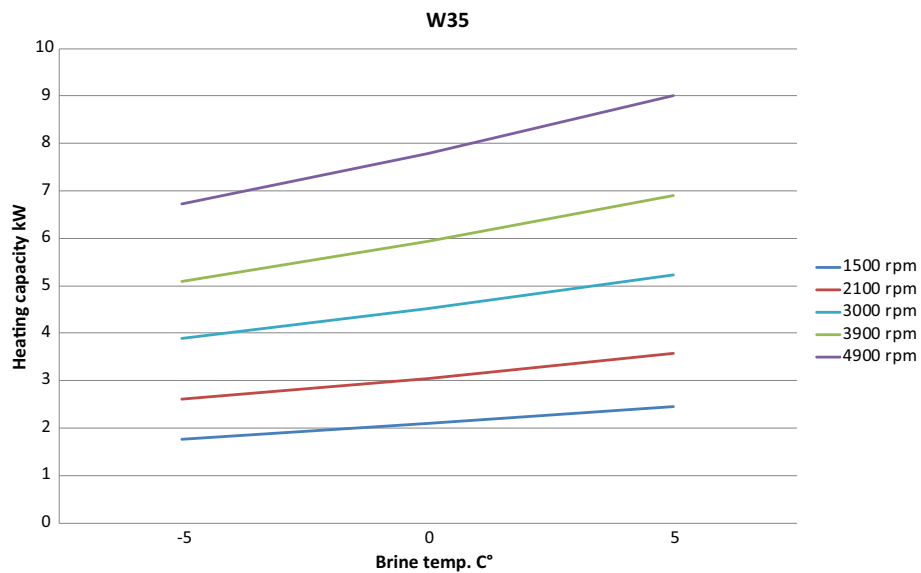

RPM	Brine temp.	-5	0	+5
1500	Heating capacity (kW)	1,8	2,1	2,5
	Input power (kW)	0,6	0,6	0,5
	COP	3,2	3,8	4,6
2100	Heating capacity (kW)	2,6	3,1	3,6
	Input power (kW)	0,7	0,7	0,7
	COP	3,7	4,3	5,1
3000	Heating capacity (kW)	3,9	4,5	5,2
	Input power (kW)	1,0	1,0	1,0
	COP	3,9	4,5	5,2
3900	Heating capacity (kW)	5,1	5,9	6,9
	Input power (kW)	1,3	1,4	1,4
	COP	3,8	4,4	5,1
4900	Heating capacity (kW)	6,7	7,8	9,0
	Input power (kW)	1,7	1,7	1,7
	COP	4,0	4,6	5,3

Heating capacity with a desired supply line temperature at 55°C at different compressor speed and brine temperature.

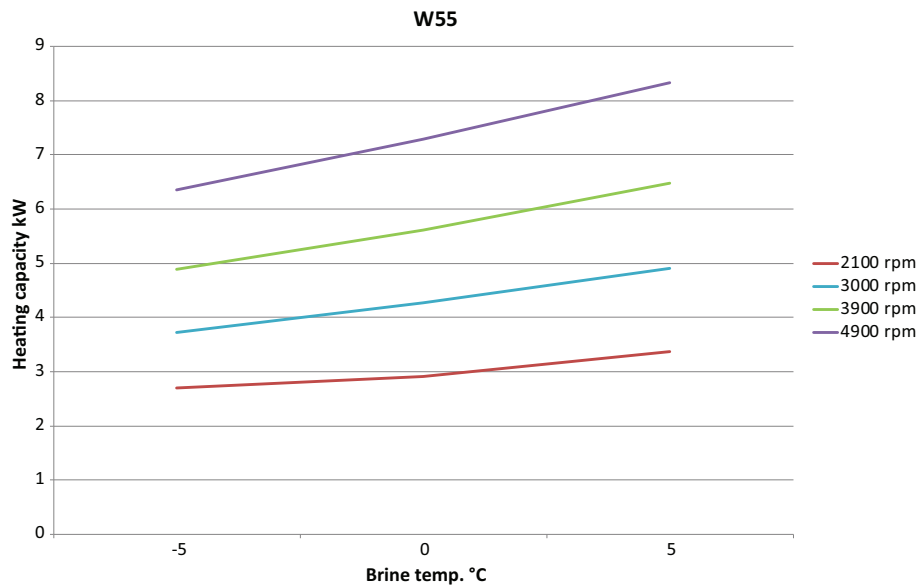

RPM	Brine temp.	-5	0	+5
1500	Heating capacity (kW)	0,0	0,0	0,0
	Input power (kW)	0,0	0,0	0,0
	COP	0,0	0,0	0,0
2100	Heating capacity (kW)	2,7	2,9	3,4
	Input power (kW)	1,0	1,1	1,1
	COP	2,6	2,7	3,1
3000	Heating capacity (kW)	3,7	4,3	4,9
	Input power (kW)	1,5	1,5	1,5
	COP	2,6	2,9	3,3
3900	Heating capacity (kW)	4,9	5,6	6,5
	Input power (kW)	1,9	1,9	2,0
	COP	2,6	2,9	3,3
4900	Heating capacity (kW)	6,4	7,3	8,3
	Input power (kW)	2,4	2,5	2,5
	COP	2,7	3,0	3,3

Technical description Atlas & Calibra models

7 Calibra Eco 12 230V & 400V

7.1 Technical data, Calibra Eco 12

Calibra Eco 12		Unit	3-12 kW
Refrigerant	Type		R452B
	Amount ¹	kg	1,30
	CO ² equivalent	tons	0,907
	Design pressure	Bar (g)	45
Compressor	Type		Scroll
	Oil		POE
Electrical data, 400V, 3N~	Mains power supply	Volt	400V 3N~
	Max working power, compressor	kW	4,1
	Rated power, circulation pumps	kW	0,2
	Immersion heater, 3 steps	kW	(0)/3/6/9
	Fuses, combined ^{2A, 2B}	A	(10)/13/20/25 ^{2B}
	Fuse separate supply, compressor only		N/A
	Fuse separate supply, immersion heater only		N/A
Electrical data, 230V, 1N~	Mains power supply	Volt	230V 1N~
	Max working power, compressor	kW	4,6
	Rated power, circulation pumps	kW	0,2
	Immersion heater, 3 steps	kW	(0)/3/5/8
	Fuses, combined ^{2C}	A	(25)/40/50/63 ^{2C}
	Fuse separate supply, compressor only		25
	Fuse separate supply, immersion heater only		16/25/40
Electrical data, 230V, 3~	Mains power supply	Volt	230V 3~
	Max working power, compressor	kW	4,6
	Rated power, circulation pumps	kW	0,2
	Immersion heater, 3 steps	kW	(0)/3/5/8
	Fuses, combined ^{2C}	A	(25)/32/32/40 ^{2C}
	Fuse separate supply, compressor only		25
	Fuse separate supply, immersion heater only		13/20/32
Performance	SCOP, floor heating (35°C) ³		5,85
	SCOP, radiator heating (55°C) ³		4,39
	COP ⁴		4,78
Energy class-system ⁵	Floor heating (35°C)		A+++
	Radiator heating (55°C)		A+++
Energy class-product ⁶	Floor heating (35°C)		A+++
	Radiator heating (55°C)		A+++
	Hot water (Economy) ⁷		A
	Hot water (Normal/Comfort) ⁸		A
Max/Min temperature	Brine	°C	20/-10
	Heating	°C	65/20
Max pressure	Brine	bar(g)	3
	Heating	bar(g)	3
Anti freeze type ⁹	Ethanol + water solution -17°C ± 2		

Technical description Atlas & Calibra models

Pressure limits refrigerant circuit	Low pressure	bar(g)	2,3
	Operating pressure	bar(g)	41,5
	High pressure	bar(g)	45,0
Sound power level	Calibra Eco	dB(A)	29-44 ¹⁰ (34) ¹¹
	Calibra Eco Duo	dB(A)	30-46 ¹⁰ (36) ¹¹
Hot water performance	Volume 40°C hot water ¹²	l	260
	COP, hot water ⁷		2,80
	Hot water including HGW ¹³	l	n/a
Hot water tank, size	Calibra Eco	l	184
	Calibra Eco Duo	l	Optional
Water mains		bar(g)	9
Weight	Calibra Eco, empty	kg	162
	Calibra Eco, filled	kg	352
	Calibra Eco Duo	kg	127
Dimensions (WxDxH)	Calibra Eco	mm	598x703x1863 +/-10
	Calibra Eco Duo	mm	598x703x1450 +/-10

1) The refrigerant circuit is hermetically sealed and contains refrigerants covered by the F-gas regulation. GWP for R452B according to EC 517/2014 is 698.

2A) The minimum recommended fuse size depends on the limitation of the electrical immersion heater in combination with the compressor. The maximum permissible power for immersion heater can also be set differently with and without compressor for further adjustment at low fuses. Control and circulation pumps are operated with L1. Immersion heater is powered by L1 and L2, frequency converter for the compressor is powered by L3. Complies with IEC 61000-3-12 without conditional connection. 230V versions: The feeding for immersion heater and compressor can be physically separated.

2B) The minimum recommended fuse size depends on the limitation of the electrical immersion heater in combination with the compressor. The maximum permissible power for immersion heater can also be set differently with and without compressor for further adjustment at low fuses. Control and circulation pumps are operated with L1. 400V versions: The power supply and the frequency converter for the compressor are powered by L1, L2 and L3. Meets IEC 61000-3-12 at Ssc connection point Calibra Eco 12 <1.3 MVA, Calibra Eco 16 <1.8 MVA without action. Calibra Eco 12 230V: The feeding for immersion heater and compressor can be physically separated. Complies with IEC 61000-3-12 without conditional connection.

2C) The minimum recommended fuse size depends on the limitation of the electrical immersion heater in combination with the compressor. The maximum permissible power for immersion heater can also be set differently with and without compressor for further adjustment at low fuses. Connection of the 230V version can be done to single phase or 3 phase 230V grids, either with one common supply, or with physically separated supplies to heat pump (compressor) and to immersion heater to lower the fuse needed. Complies with IEC 61000-3-12 without conditional connection.

3) SCOP according to EN14825, cold climate (Helsinki), P-design Calibra Eco 8: 6,2 kW (B0W55), 6,7 kW (B0W35). P-design Calibra Eco 12: 10,6 kW (B0W55), 11,5 kW (B0W35). P-design Calibra Eco 16: 14,7 kW (B0W55), 15,9 kW (B0W35)

4) At B0/W35, according to EN14511

5) When the heat pump is installed in a heating system that is controlled via the heat pump's control computer. According to EU regulation 811/2013.

6) When the heat pump is not connected to a heating system, and the function of the built-in control computer is not taken into account. According to EU regulation 811/2013.

7) Hot water performance according to EN16147, COP according to XL cycle with the control computer set for Economy mode and built-in hot water tank.

8) Hot water performance according to EN16147, COP according to XL cycle with the control computer set for Normal / Comfort mode and built-in processor.

9) Local regulations and regulations must always be checked before antifreeze agents are used.

10) Sound power level measured according to EN12102 and EN 3741 (min / max B0W35).

11) Sound power level according to energy labeling, measured according to EN12102 and EN3741 (B0W55).

12) Hot water performance according to EN16147, V40 according to XL cycle with the control computer set for comfort mode and built-in hot water tank.

7.2 Estimated flow and pressure for brine, Calibra Eco 12 and Calibra Eco Duo 12

Flow brine and external available pressure B0W35 (Δt 3)

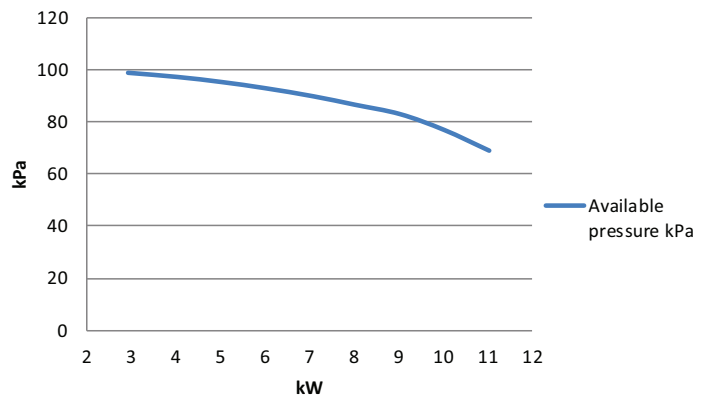
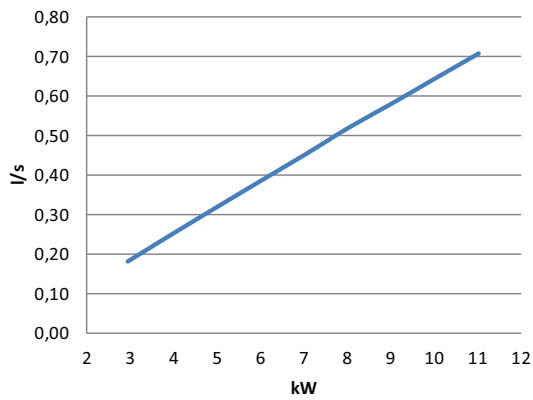

Flow brine and external available pressure B0W55 (Δt 3)

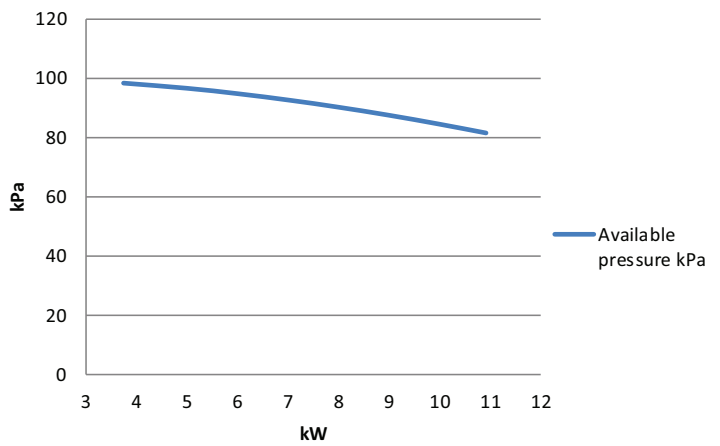
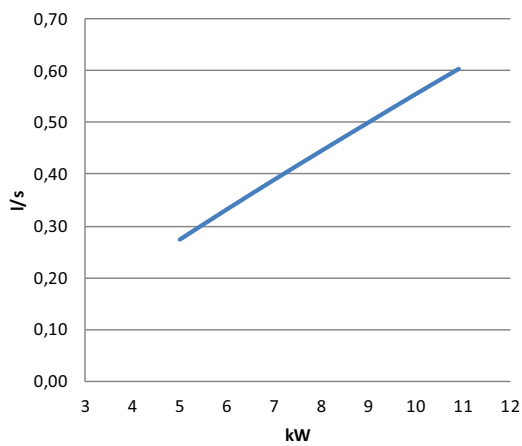

7.3 Estimated flow and pressure for heating circuit, Calibra Eco 12 and Calibra Eco Duo 12

Flow heating circuit and external available pressure B0W35 (Δt 5)

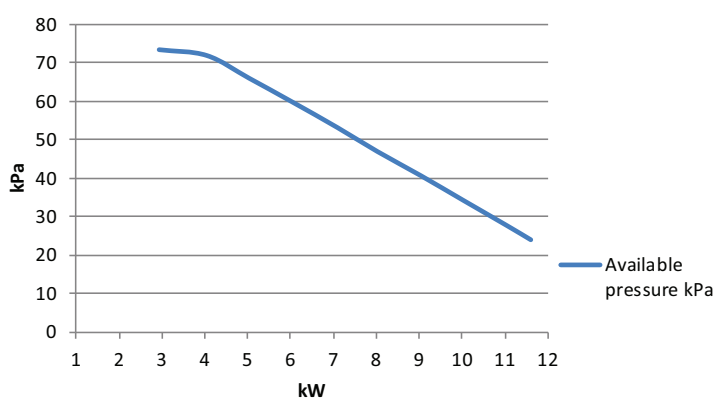
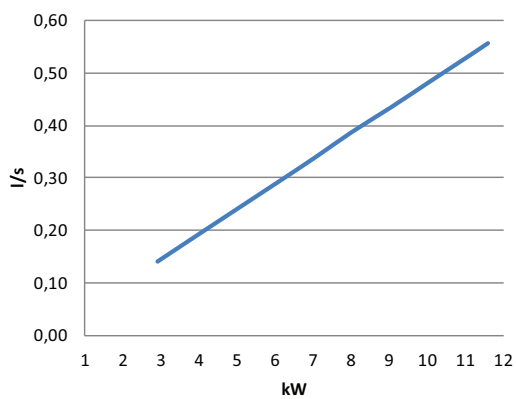

Flow heating circuit and external available pressure B0W55 (Δt 8)

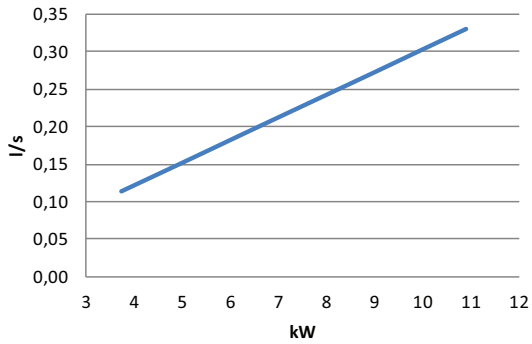

Flow l/s

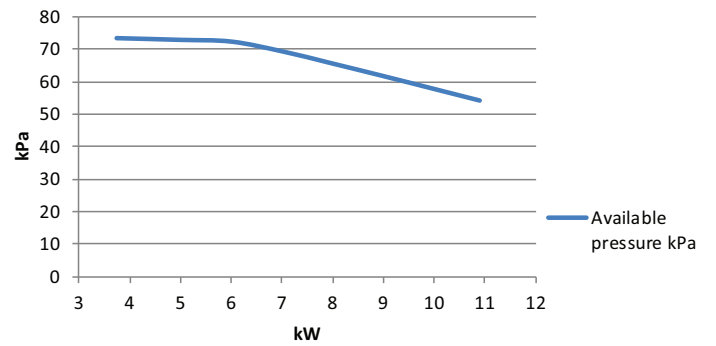

Available pressure kPa

Technical description Atlas & Calibra models

7.4 Supply line temp 35° and 55°C for Calibra Eco12 and Calibra Eco Duo 12

Heating capacity with a desired supply line temperature at 35°C at different compressor speed and brine temperature.

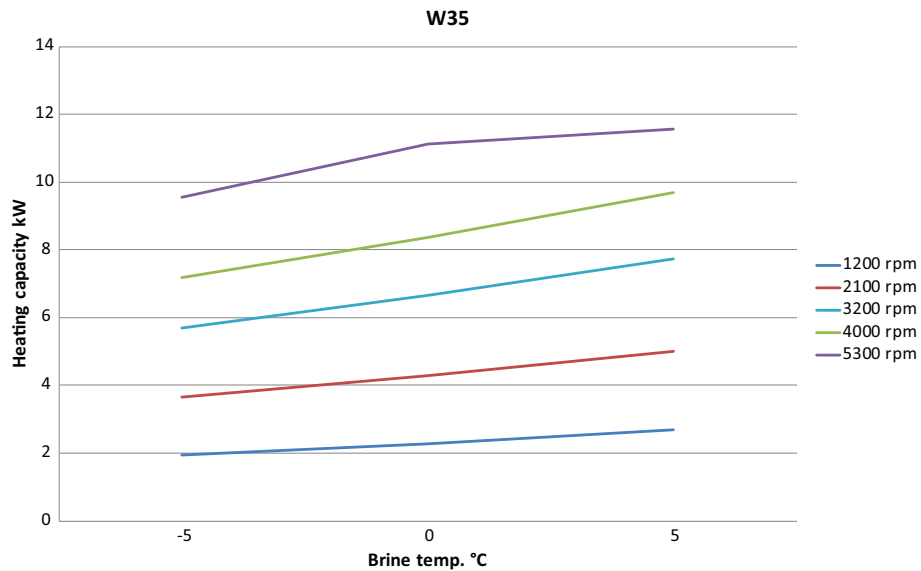

RPM	Brine temp.	-5	0	+5
1200	Heating capacity (kW)	1,9	2,3	2,7
	Input power (kW)	0,6	0,6	0,6
	COP	3,0	3,7	4,4
2100	Heating capacity (kW)	3,7	4,3	5,0
	Input power (kW)	1,0	1,0	0,9
	COP	3,8	4,5	5,4
3200	Heating capacity (kW)	5,7	6,7	7,7
	Input power (kW)	1,4	1,4	1,4
	COP	4,1	4,7	5,5
4000	Heating capacity (kW)	7,2	8,4	9,7
	Input power (kW)	1,8	1,8	1,8
	COP	4,1	4,7	5,4
5300	Heating capacity (kW)	9,6	11,1	11,6
	Input power (kW)	2,4	2,5	2,5
	COP	3,9	4,5	4,6

Technical description Atlas & Calibra models

Heating capacity with a desired supply line temperature at 55°C at different compressor speed and brine temperature.

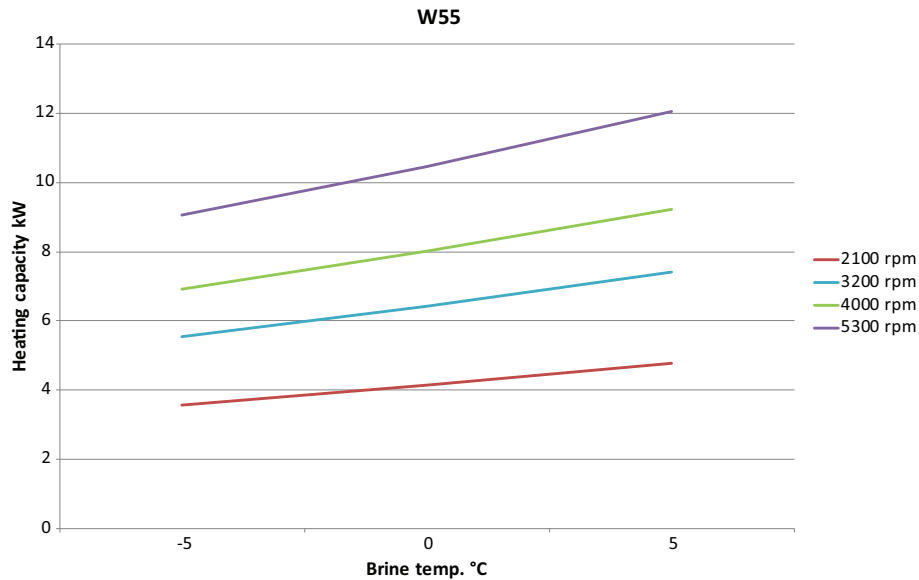

RPM	Brine temp.	-5	0	+5
1200	Heating capacity (kW)	0,0	0,0	0,0
	Input power (kW)	0,0	0,0	0,0
	COP	0,0	0,0	0,0
2100	Heating capacity (kW)	3,6	4,1	4,8
	Input power (kW)	1,4	1,4	1,5
	COP	2,5	2,9	3,3
3200	Heating capacity (kW)	5,5	6,4	7,4
	Input power (kW)	2,0	2,1	2,1
	COP	2,7	3,1	3,5
4000	Heating capacity (kW)	6,9	8,0	9,2
	Input power (kW)	2,5	2,6	2,6
	COP	2,8	3,1	3,5
5300	Heating capacity (kW)	9,1	10,5	12,1
	Input power (kW)	3,4	3,5	3,6
	COP	2,7	3,0	3,4

8 Calibra Eco 16 400V

8.1 Technical data, Calibra Eco 16

Calibra Eco 16 400V		Unit	4-16 kW
Refrigerant	Type		R452B
	Amount ¹	kg	1,85
	CO ² equivalent	tons	1,291
	Design pressure	Bar (g)	45
Compressor	Type		Scroll
	Oil		POE
Electrical data, 400V, 3N~	Mains power supply	Volt	400V 3N~
	Max working power, compressor	kW	6
	Rated power, circulation pumps	kW	0,3
	Immersion heater, 3 steps	kW	(0)/3/6/9
	Fuses, combined ^{2A, 2B}	A	(13)/16/25/25 ^{2B}
	Fuse separate supply, compressor only	A	N/A
	Fuse separate supply, immersion heater only	A	N/A
Performance	SCOP, floor heating (35°C) ³		5,98
	SCOP, radiator heating (55°C) ³		4,54
	COP ⁴		4,87
Energy class-system ⁵	Floor heating (35°C)		A+++
	Radiator heating (55°C)		A+++
Energy class-product ⁶	Floor heating (35°C)		A+++
	Radiator heating (55°C)		A+++
	Hot water (Economy) ⁷		A
	Hot water (Normal/Comfort) ⁸		A
Max/Min temperature	Brine	°C	20/-10
	Heating	°C	65/20
Max pressure	Brine	bar(g)	3
	Heating	bar(g)	3
Anti freeze type ⁹	Ethanol + water solution -17°C ± 2		
Pressure limits refrigerant circuit	Low pressure	bar(g)	2,3
	Operating pressure	bar(g)	41,5
	High pressure	bar(g)	45,0
Sound power level	Calibra Eco	dB(A)	32-46 ¹⁰ (36) ¹¹
	Calibra Eco Duo	dB(A)	33-48 ¹⁰ (38) ¹¹
Hot water performance	Volume 40°C hot water ¹²	l	270
	COP, hot water ⁷		2,91
	Hot water including HGW ¹³	l	N/A
Hot water tank, size	Calibra Eco	l	184
	Calibra Eco Duo	l	Optional
Water mains		bar(g)	9
Weight	Calibra Eco, empty	kg	176
	Calibra Eco, filled	kg	366
	Calibra Eco Duo	kg	141

Technical description Atlas & Calibra models

Dimensions (WxDxH)	Calibra Eco	mm	598x703x1863 +/-10
	Calibra Eco Duo	mm	598x703x1450 +/-10

- 1) The refrigerant circuit is hermetically sealed and contains refrigerants covered by the F-gas regulation. GWP for R452B according to EC 517/2014 is 698.
- 2A) The minimum recommended fuse size depends on the limitation of the electrical immersion heater in combination with the compressor. The maximum permissible power for immersion heater can also be set differently with and without compressor for further adjustment at low fuses. Control and circulation pumps are operated with L1. Immersion heater is powered by L1 and L2, frequency converter for the compressor is powered by L3. Complies with IEC 61000-3-12 without conditional connection. 230V versions: The feeding for immersion heater and compressor can be physically separated.
- 2B) The minimum recommended fuse size depends on the limitation of the electrical immersion heater in combination with the compressor. The maximum permissible power for immersion heater can also be set differently with and without compressor for further adjustment at low fuses. Control and circulation pumps are operated with L1. 400V versions: The power supply and the frequency converter for the compressor are powered by L1, L2 and L3. Meets IEC61000-3-12 at Ssc connection point Calibra Eco 12 <1.3 MVA, Calibra Eco 16 <1.8 MVA without action. Calibra Eco 12 230V: The feeding for immersion heater and compressor can be physically separated. Complies with IEC 61000-3-12 without conditional connection.
- 3) SCOP according to EN14825, cold climate (Helsinki), P-design Calibra Eco 8: 6,2 kW (B0W55), 6,7 kW (B0W35). P-design Calibra Eco 12: 10,6 kW (B0W55), 11,5 kW (B0W35). P-design Calibra Eco 16: 14,7 kW (B0W55), 15,9 kW (B0W35)
- 4) At B0/W35, according to EN14511
- 5) When the heat pump is installed in a heating system that is controlled via the heat pump's control computer. According to EU regulation 811/2013.
- 6) When the heat pump is not connected to a heating system, and the function of the built-in control computer is not taken into account. According to EU regulation 811/2013.
- 7) Hot water performance according to EN16147, COP according to XL cycle with the control computer set for Economy mode and built-in hot water tank.
- 8) Hot water performance according to EN16147, COP according to XL cycle with the control computer set for Normal / Comfort mode and built-in processor.
- 9) Local regulations and regulations must always be checked before antifreeze agents are used.
- 10) Sound power level measured according to EN12102 and EN 3741 (min / max B0W35).
- 11) Sound power level according to energy labeling, measured according to EN12102 and EN3741 (B0W55).
- 12) Hot water performance according to EN16147, V40 according to XL cycle with the control computer set for comfort mode and built-in hot water tank.

8.2 Estimated flow and pressure for brine for Calibra Eco 16

Flow brine and external available pressure B0W35 (Δt 3)

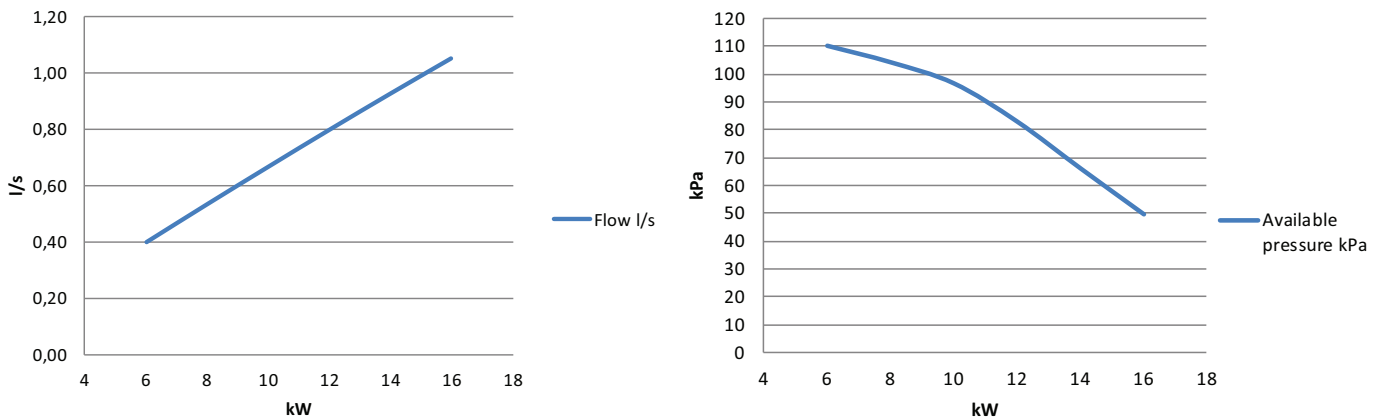

Flow brine and external available pressure B0W55 (Δt 3)

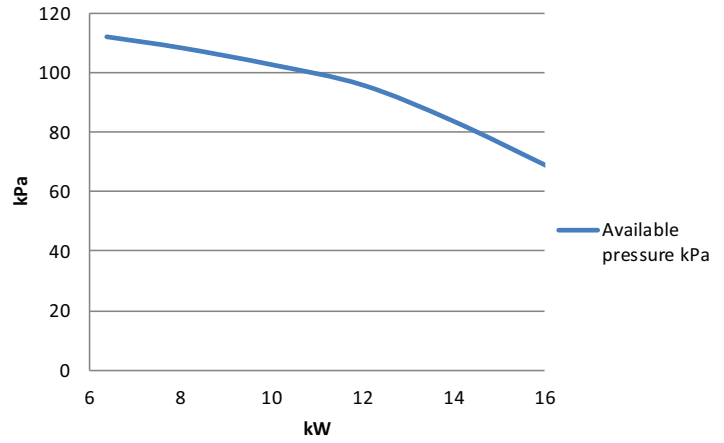
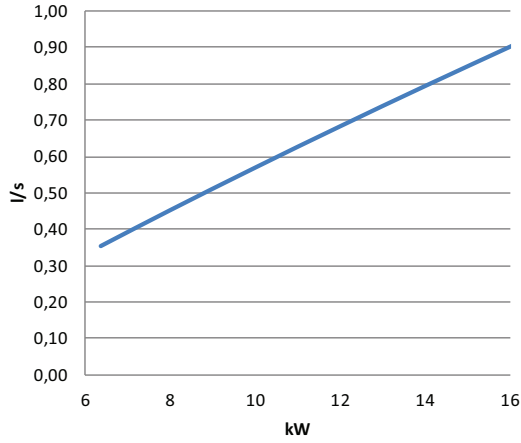

8.3 Estimated flow and pressure for heating circuit, Calibra Eco 16

Flow heating circuit and external available pressure B0W35 (Δt 5)

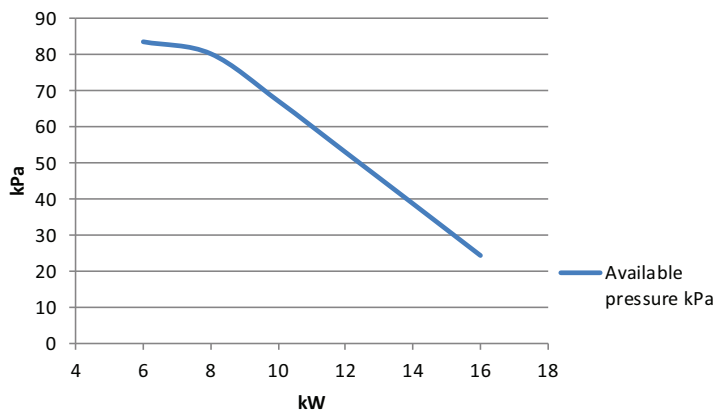
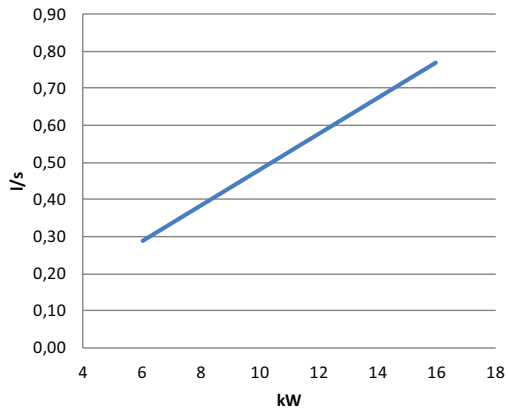

Flow heating circuit and external available pressure B0W55 (Δt 8)

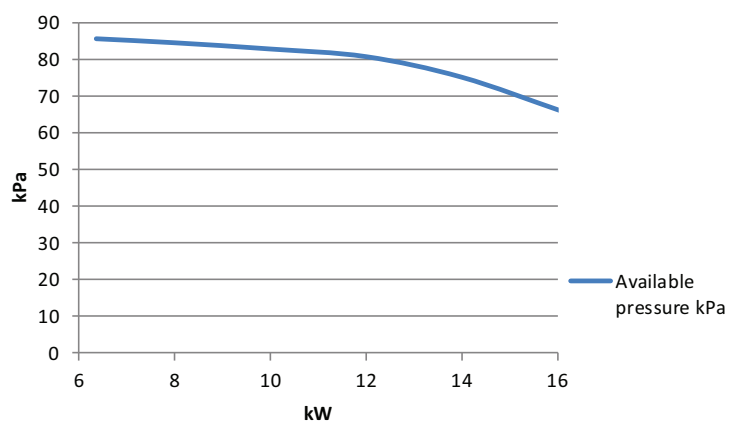
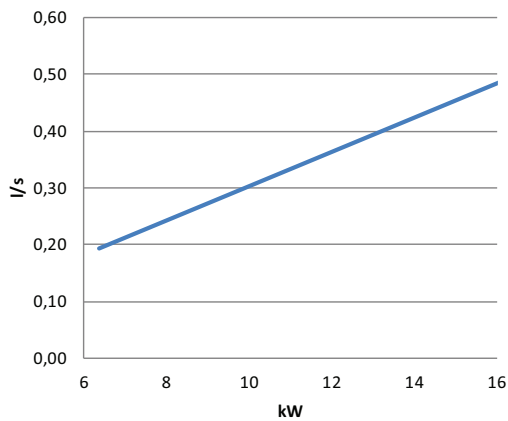

Technical description Atlas & Calibra models

8.4 Supply line temp 35° and 55°C for Calibra Eco 16 and Calibra Eco Duo 16

Heating capacity with a desired supply line temperature at 35° at different compressor speed and brine temperatures.

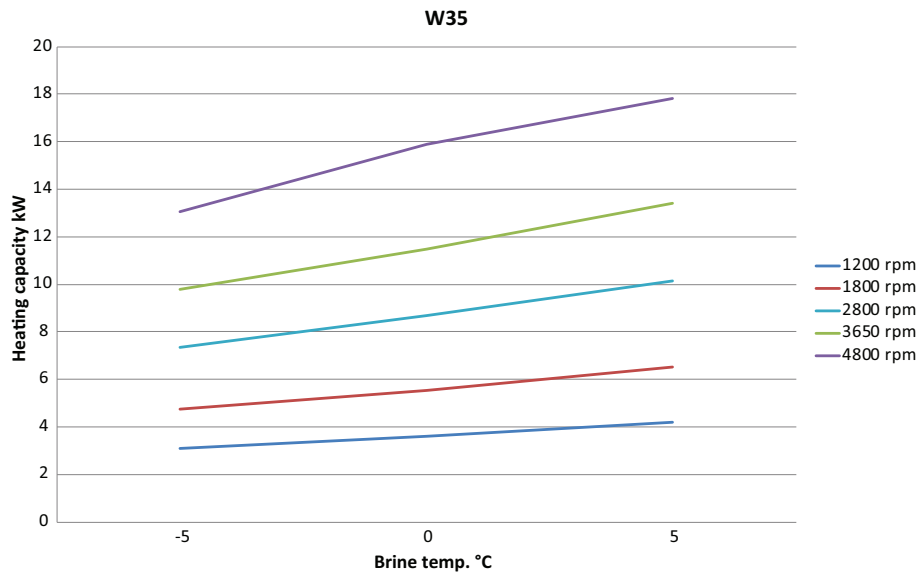

RPM	Brine temp.	-5	0	+5
1200	Heating capacity (kW)	3,1	3,6	4,2
	Input power (kW)	0,9	0,9	0,8
	COP	3,6	4,3	5,2
1800	Heating capacity (kW)	4,7	5,6	6,5
	Input power (kW)	1,2	1,2	1,1
	COP	4,0	4,8	5,7
2800	Heating capacity (kW)	7,4	8,7	10,1
	Input power (kW)	1,7	1,8	1,8
	COP	4,2	5,0	5,8
3650	Heating capacity (kW)	9,8	11,5	13,4
	Input power (kW)	2,3	2,3	2,4
	COP	4,3	5,0	5,7
4800	Heating capacity (kW)	13,0	15,9	17,8
	Input power (kW)	3,1	3,5	3,3
	COP	4,2	4,6	5,4

Technical description Atlas & Calibra models

Heating capacity with a desired supply line temperature at 55° at different compressor speed and brine temperatures.

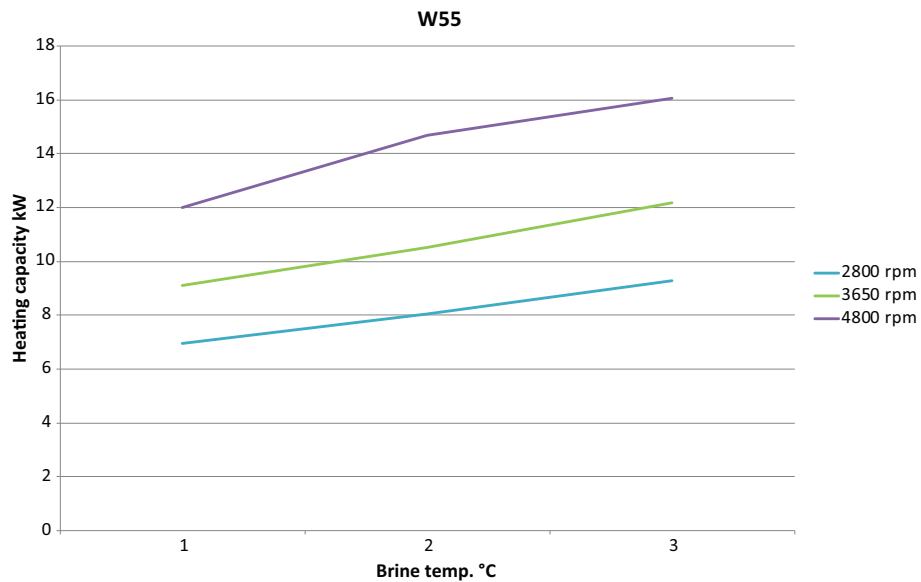

RPM	Brine temp.	-5	0	+5
1200	Heating capacity (kW)	0,0	0,0	0,0
	Input power (kW)	0,0	0,0	0,0
	COP	0,0	0,0	0,0
1800	Heating capacity (kW)	0,0	0,0	0,0
	Input power (kW)	0,0	0,0	0,0
	COP	0,0	0,0	0,0
2800	Heating capacity (kW)	7,0	8,0	9,3
	Input power (kW)	2,6	2,7	2,7
	COP	2,6	3,0	3,4
3650	Heating capacity (kW)	9,1	10,5	12,2
	Input power (kW)	3,4	3,4	3,5
	COP	2,7	3,1	3,5
4800	Heating capacity (kW)	12,0	14,7	16,1
	Input power (kW)	4,4	4,7	4,7
	COP	2,7	3,1	3,4

9 Atlas 12 400V & 230V

9.1 Technical data, Atlas 12

Atlas 12 400V and 230V		Unit	3-12 kW
Refrigerant	Type		R410A
	Amount ¹	kg	1,40
	GWP		2088
	CO ² equivalent	tons	2,923
	Design pressure	Bar (g)	45
Compressor	Type		Scroll
	Oil		POE
Electrical data, 400V, 3N~	Mains power supply	Volt	400 3N~
	Max working power, compressor	kW	4,3
	Rated power, circulation pumps	kW	0,2
	Immersion heater, 3 steps	kW	0/3/6/9
	Fuses, combined ²	A	(10)/16/20/25
Electrical data, 230V, 3~	Mains power supply	Volt	230 3~
	Max working power, compressor	kW	4,3
	Rated power, circulation pumps	kW	0,2
	Immersion heater, 3 steps	kW	0/3/5/8
	Fuses, combined ²	A	(25)/32/32/40
	Fuse separate supply (compressor only)	A	25
	Fuse separate supply, Immersion heater only	A	13/20/32
Electrical data, 230V, 1N~	Mains power supply	Volt	230 1N~
	Max working power, compressor	kW	4,3
	Rated power, circulation pumps	kW	0,2
	Immersion heater, 3 steps	kW	0/3/5/8
	Fuses, combined ²	A	(25)/40/50/63
	Fuse separate supply (compressor only)	A	25
	Fuse separate supply, Immersion heater only	A	16/25/40
Performance	SCOP, floor heating (35°C) ³		5,86
	SCOP, radiator heating (55°C) ³		4,39
	COP ⁴		4,75
Energy class-system ⁵	Floor heating (35°C)		A+++
	Radiator heating (55°C)		A+++
Energy class-product ⁶	Floor heating (35°C)		A+++
	Radiator heating (55°C)		A+++
	Hot water (Economy) ⁷		A+
	Hot water (Normal/Comfort) ⁸		A
Min/Max temperature	Brine	°C	20/-10
	Heating	°C	65/20
Anti freeze type ⁹	Ethanol + water solution -17°C ± 2		
Pressure limits refrigerant circuit	Low pressure	bar(g)	2,3
	Operating pressure	bar(g)	41,5
	High pressure	bar(g)	45,0

Technical description Atlas & Calibra models

Sound power level	Atlas	dB(A)	30-43 ¹⁰ (33) ¹¹
	Atlas Duo	dB(A)	31-45 ¹⁰ (34) ¹¹
Hot water performance	Volume 40°C hot water ¹²	l	307
	COP, hot water ⁷		3,07
	Hot water including HGW ¹³	l	488
Hot water tank, size	Atlas	l	184
	Atlas Duo	l	Optional
Water mains		bar(g)	10 Max
Weight	Atlas, empty	kg	177
	Atlas, filled	kg	367
	Atlas Duo	kg	127
Dimensions (WxDxH)	Atlas	mm	598x703x1863 +/-10
	Atlas Duo	mm	598x703x1450 +/-10

1) The refrigerant circuit is hermetically sealed and contains refrigerants covered by the F-gas regulation. GWP for R410A according to EC 517/2014 is 2088, which gives a CO2 equivalent corresponding to Atlas 12: 2.923 tons, Atlas 18: 4.072 tons.

2) The minimum recommended fuse size depends on the limitation of the electrical immersion heater in combination with the compressor. The maximum permissible power for immersion heater can also be set differently with and without compressor for further adjustment at low fuses. 400V versions: The power supply and the frequency converter for the compressor are powered by L1, L2 and L3. Control and circulation pumps are operated with L1. Meets IEC61000-3-12 at Ssc connection point <1.3 MVA for Atlas 12 and for Atlas 18 <2.1 MVA without action. 230V versions: The feeding for immersion heater and compressor can be physically separated.

3) SCOP according to EN14825, cold climate (Helsinki), P-design Atlas 12: 10.5 kW (B0W55), 11.5 kW (B0W35). P-design Atlas 18: 15.7 kW (B0W55), 15.1 kW (B0W35).

4) At B0 / W35, according to EN14511

5) When the heat pump is installed in a heating system that is controlled via the heat pump's control computer. According to EU regulation 811/2013.

6) When the heat pump is not connected to a heating system, and the function of the built-in control computer is not taken into account. According to EU regulation 811/2013.

7) Hot water performance according to EN16147, COP according to XL cycle with the control computer set for Economy mode and built-in hot water tank.

8) Hot water performance according to EN16147, COP according to XL cycle with the control computer set for Normal / Comfort mode and built-in processor.

9) Local regulations and regulations must always be checked before antifreeze agents are used.

10) Sound power level measured according to EN12102 and EN 3741 (min / max B0W35).

11) Sound power level according to energy labeling, measured according to EN12102 and EN3741 (B0W55).

12) Hot water performance according to EN16147, V40 according to XL cycle with the control computer set for comfort mode and built-in hot water tank.

13) Maximum available amount of hot water when the boiler has been able to fully charge using HGW operation and subsequent V40 discharge in accordance with EN16147

9.2 Estimated flow and pressure for brine for Atlas 12

Flow brine and external available pressure B0W35 (Δt 3)

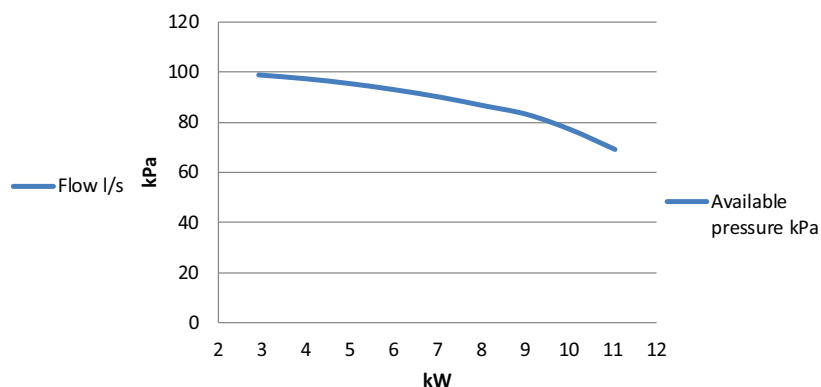
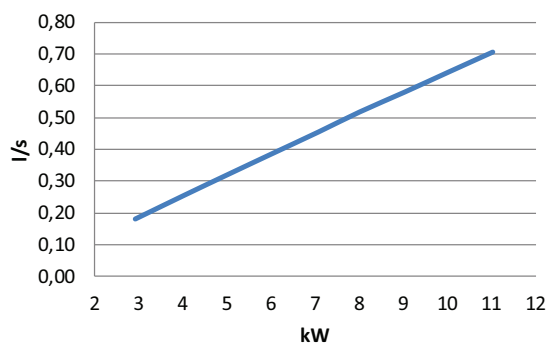

Flow brine and external available pressure B0W55 (Δt 3)

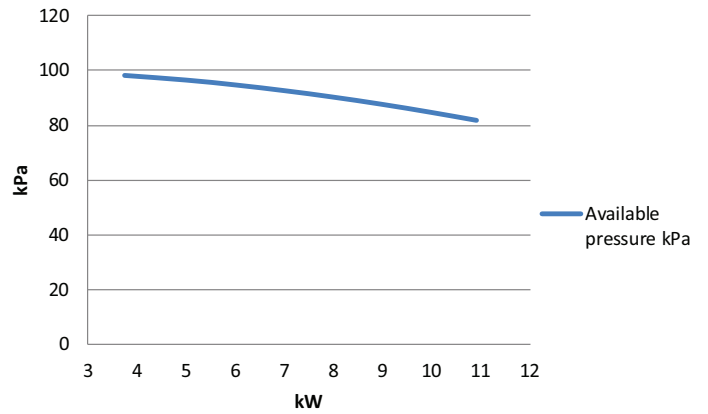
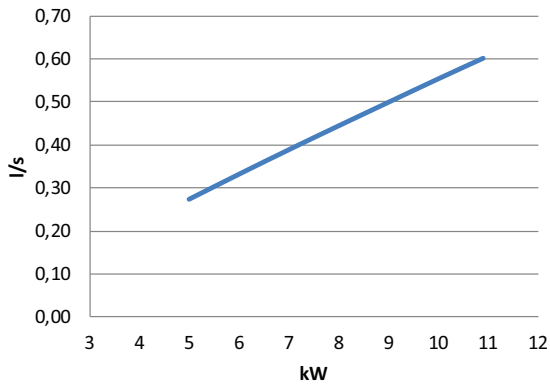

9.3 Estimated flow and pressure for heating circuit, Atlas 12

Flow heating circuit and external available pressure B0W35 (Δt 5)

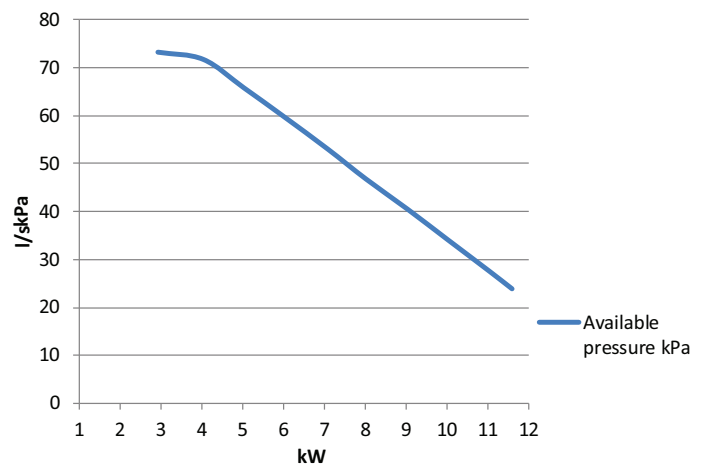
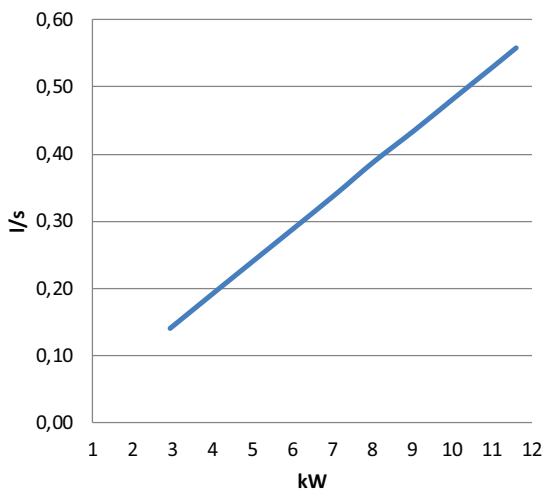

Flow heating circuit and external available pressure B0W55 (Δt 8)

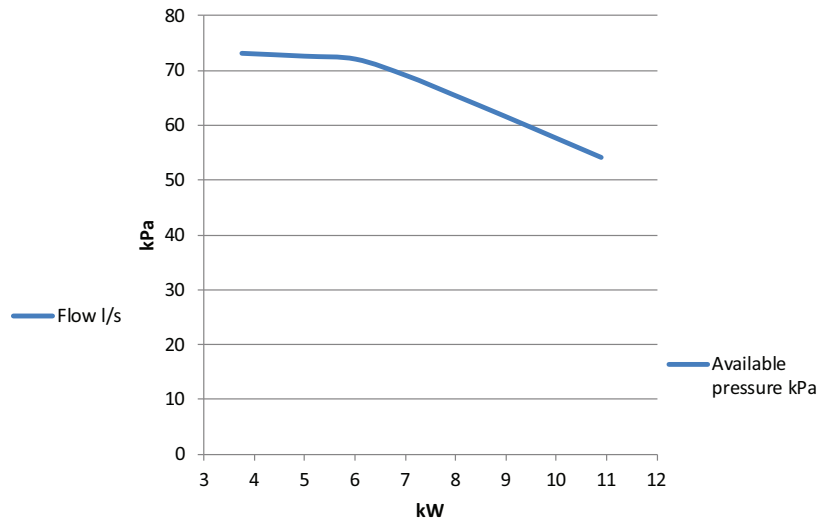
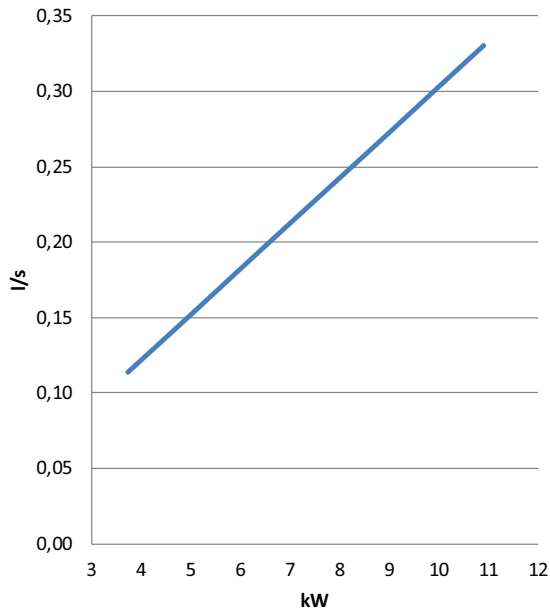

Technical description Atlas & Calibra models

9.4 Supply line temp 35° and 55°C for Atlas 12 and Atlas Duo 12

Heating capacity with a desired supply line temperature at 35°C at different compressor speed and brine temperature. At higher brine temperatures max compressor speed may be automatically reduced to below 5300 max RPM

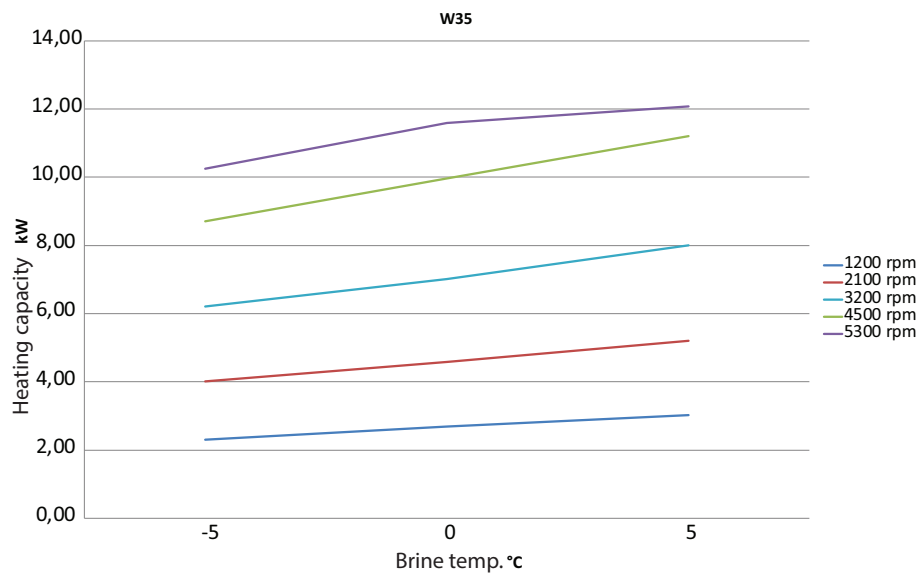

RPM	Brine temp.	-5	0	+5
1200	Heating capacity (kW)	2,3	2,7	3,0
	Input power (kW)	0,7	0,7	0,7
	COP	3,5	4,1	4,6
2100	Heating capacity (kW)	4,0	4,6	5,2
	Input power (kW)	1,0	1,0	1,0
	COP	4,0	4,6	5,3
3200	Heating capacity (kW)	6,2	7,0	8,0
	Input power (kW)	1,5	1,5	1,5
	COP	4,1	4,7	5,3
4500	Heating capacity (kW)	8,7	10,0	11,2
	Input power (kW)	2,2	2,2	2,2
	COP	4,0	4,6	5,2
5300	Heating capacity (kW)	10,2	11,6	12,1
	Input power (kW)	2,6	2,7	2,7
	COP	3,9	4,4	4,6

Technical description Atlas & Calibra models

Heating capacity with a desired supply line temperature at 55°C at different compressor speed and brine temperature. At higher brine temperatures max compressor speed may be automatically reduced to below 5300 max RPM

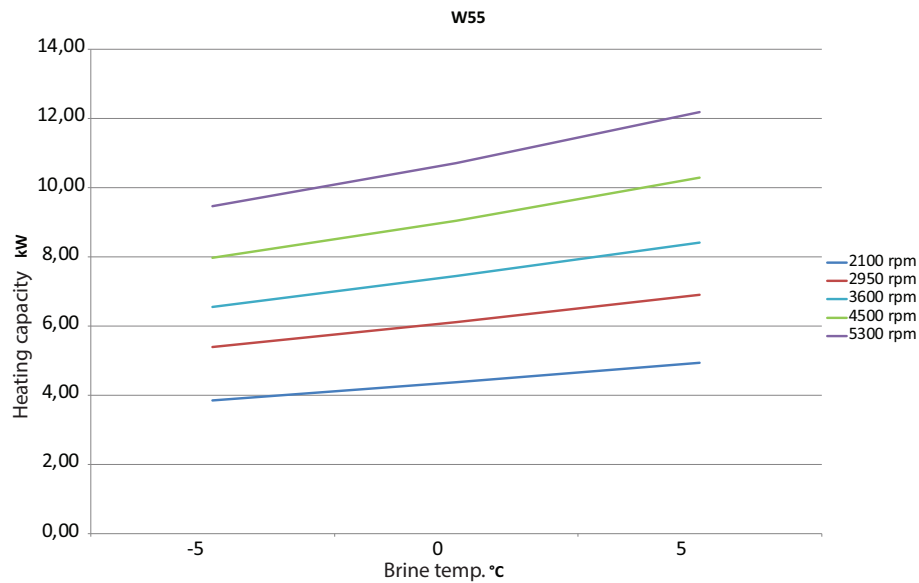

RPM	Brine temp.	-5	0	+5
2100	Heating capacity (kW)	3,9	4,4	4,9
	Input power (kW)	1,5	1,5	1,5
	COP	2,6	2,9	3,2
2950	Heating capacity (kW)	5,4	6,1	6,9
	Input power (kW)	2,0	2,0	2,1
	COP	2,7	3,0	3,4
3600	Heating capacity (kW)	6,6	7,5	8,4
	Input power (kW)	2,4	2,4	2,5
	COP	2,8	3,1	3,4
4500	Heating capacity (kW)	8,0	9,1	10,3
	Input power (kW)	3,0	3,1	3,1
	COP	2,7	3,0	3,3
5300	Heating capacity (kW)	9,5	10,7	12,2
	Input power (kW)	3,7	3,7	3,8
	COP	2,6	2,9	3,2

10 Atlas 18 400V

10.1 Technical data, Atlas 18

Atlas 18 400V and 230V		Unit	4-18 kW
Refrigerant	Type		R410A
	Amount ¹	kg	1,95
	CO ² equivalent	tons	4,072
	Design pressure	Bar (g)	45
Compressor	Type		Scroll
	Oil		POE
Electrical data, 400V, 3N~	Mains power supply	Volt	400 3N~
	Max working power, compressor	kW	6,7
	Rated power, circulation pumps	kW	0,3
	Immersion heater, 3 steps	kW	(0)/3/6/9
	Fuses, combined ²	A	(13)/20/25/32
Performance	SCOP, floor heating (35°C) ³		6,15
	SCOP, radiator heating (55°C) ³		4,55
	COP ⁴		4,98
Energy class-system ⁵	Floor heating (35°C)		A+++
	Radiator heating (55°C)		A+++
Energy class-product ⁶	Floor heating (35°C)		A+++
	Radiator heating (55°C)		A+++
	Hot water (Economy) ⁷		A+
	Hot water (Normal/Comfort) ⁸		A
Min/Max temperature	Brine	°C	20/-10
	Heating	°C	65/20
Anti freeze type ⁹	Ethanol + water solution -17°C ± 2		
Pressure limits refrigerant circuit	Low pressure	bar(g)	2,3
	Operating pressure	bar(g)	41,5
	High pressure	bar(g)	45,0
Sound power level	Atlas	dB(A)	32-45 ¹⁰ (36) ¹¹
	Atlas Duo	dB(A)	33-46 ¹⁰ (37) ¹¹
Hot water performance	Volume 40°C hot water ¹²	l	344
	COP, hot water ⁷		3,05
	Hot water including HGW ¹³	l	545
Hot water tank, size	Atlas	l	184
	Atlas Duo	l	Optional
Water mains		bar(g)	9
Weight	Atlas, empty	kg	187
	Atlas, filled	kg	377
	Atlas Duo	kg	147
Dimensions (WxDxH)	Atlas	mm	598x703x1863 +/-10
	Atlas Duo	mm	598x703x1450 +/-10

- 1) The refrigerant circuit is hermetically sealed and contains refrigerants covered by the F-gas regulation. GWP for R410A according to EC 517/2014 is 2088, which gives a CO2 equivalent corresponding to Atlas 12: 2.923 tons, Atlas 18: 4.072 tons.
- 2) The minimum recommended fuse size depends on the limitation of the electrical immersion heater in combination with the compressor. The maximum permissible power for immersion heater can also be set differently with and without compressor for further adjustment at low fuses. 400V versions: The power supply and the frequency converter for the compressor are powered by L1, L2 and L3. Control and circulation pumps are operated with L1. Meets IEC61000-3-12 at Ssc connection point <1.3 MVA for Atlas 12 and for Atlas 18 <2.1 MVA without action.
- 3) SCOP according to EN14825, cold climate (Helsinki), P-design Atlas 12: 11 kW (B0W55), 12 kW (B0W35). P-design Atlas 18: 16 kW (B0W55), 15 kW (B0W35).
- 4) At B0 / W35, according to EN14511
- 5) When the heat pump is installed in a heating system that is controlled via the heat pump's control computer. According to EU regulation 811/2013.
- 6) When the heat pump is not connected to a heating system, and the function of the built-in control computer is not taken into account. According to EU regulation 811/2013.
- 7) Hot water performance according to EN16147, COP according to XL cycle with the control computer set for Economy mode and built-in hot water tank.
- 8) Hot water performance according to EN16147, COP according to XL cycle with the control computer set for Normal / Comfort mode and built-in processor.
- 9) Local regulations and regulations must always be checked before antifreeze agents are used.
- 10) Sound power level measured according to EN12102 and EN 3741 (min / max B0W35).
- 11) Sound power level according to energy labeling, measured according to EN12102 and EN3741 (B0W55).
- 12) Hot water performance according to EN16147, V40 according to XL cycle with the control computer set for comfort mode and built-in hot water tank.
- 13) Maximum available amount of hot water when the boiler has been able to fully charge using HGW operation and subsequent V40 discharge in accordance with EN16147

10.2 Estimated flow and pressure for brine for Atlas 18

Flow brine and external available pressure B0W35 (Δt 3)

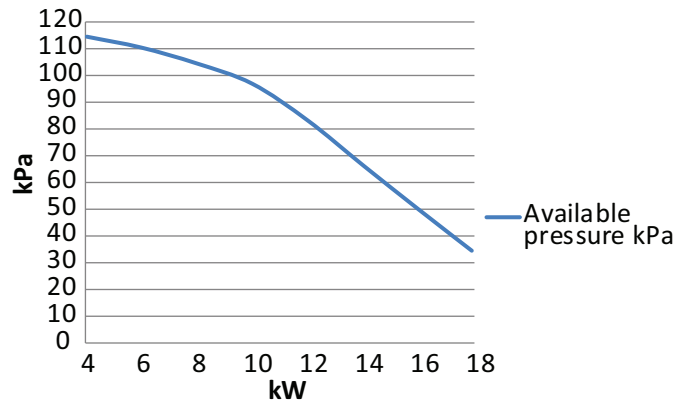
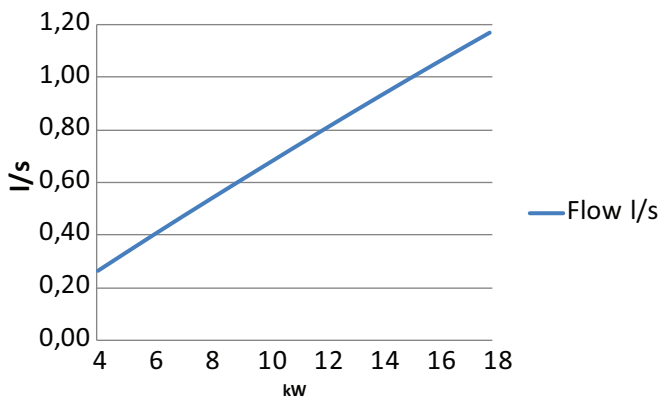

Flow brine and external available pressure B0W55 (Δt 3)

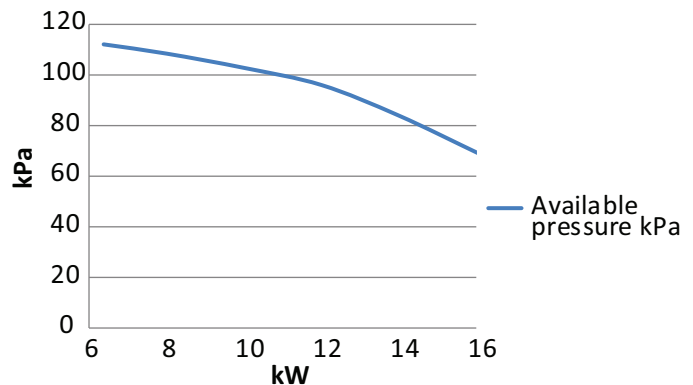
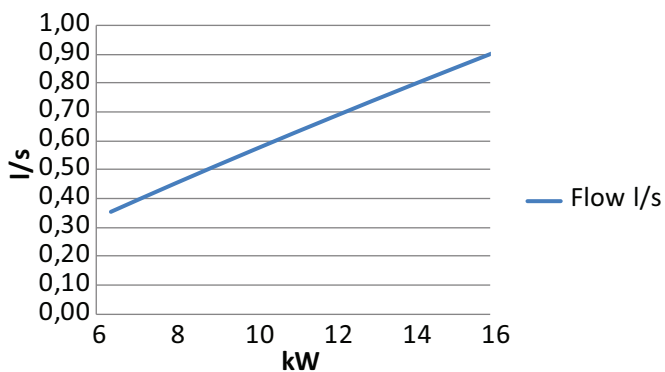

10.3 Estimated flow and pressure for heating circuit, Atlas 18

Flow heating circuit and external available pressure B0W35 (Δt 5)

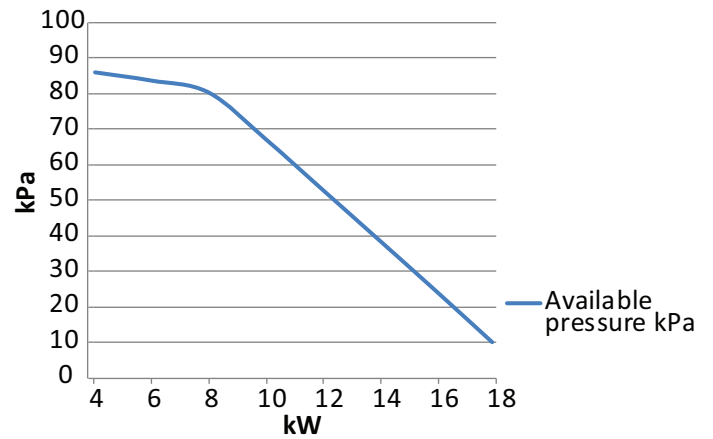
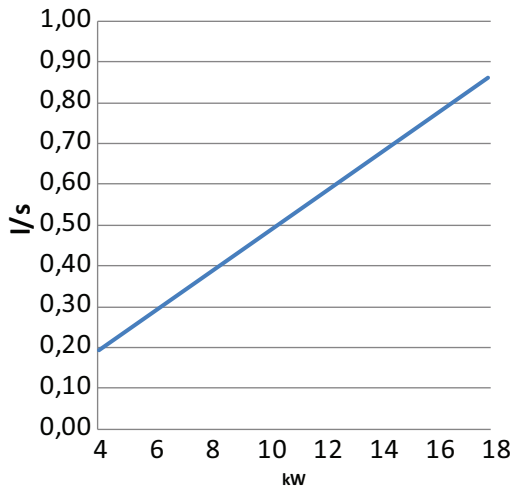

Flow heating circuit and external available pressure B0W55 (Δt 8)

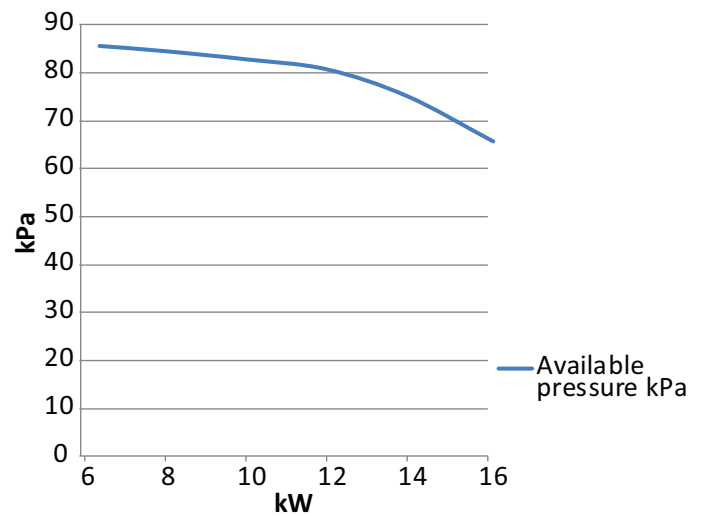
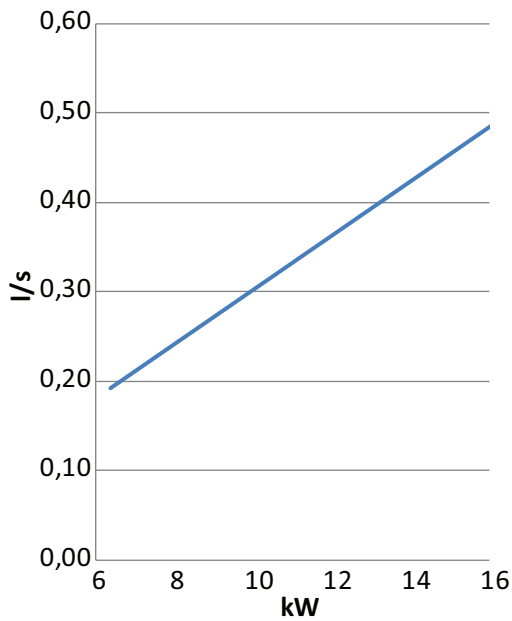

Technical description Atlas & Calibra models

10.4 Supply line temp 35° and 55°C for Atlas 18 and Atlas Duo 18

Heating capacity with a desired supply line temperature at 35° at different compressor speed and brine temperatures.

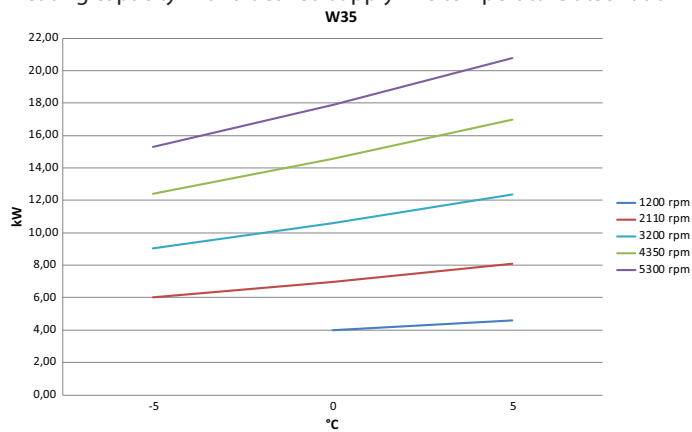

RPM	Brine temp.	-5	0	+5
1200	Heating capacity (kW)	*	4,0	4,6
	Input power (kW)	*	0,9	0,9
	COP	*	4,4	5,2
2110	Heating capacity (kW)	6,0	7,0	8,1
	Input power (kW)	1,4	1,4	1,4
	COP	4,3	5,0	5,9
3200	Heating capacity (kW)	9,0	10,6	12,3
	Input power (kW)	2,1	2,1	2,2
	COP	4,3	5,0	5,7
4350	Heating capacity (kW)	12,4	14,6	17,0
	Input power (kW)	3,0	3,1	3,2
	COP	4,2	4,8	5,3
5300	Heating capacity (kW)	15,3	17,9	20,8
	Input power (kW)	3,8	4,0	4,3
	COP	4,0	4,5	4,9

* Outside envelope

Heating capacity with a desired supply line temperature at 55° at different compressor speed and brine temperatures.

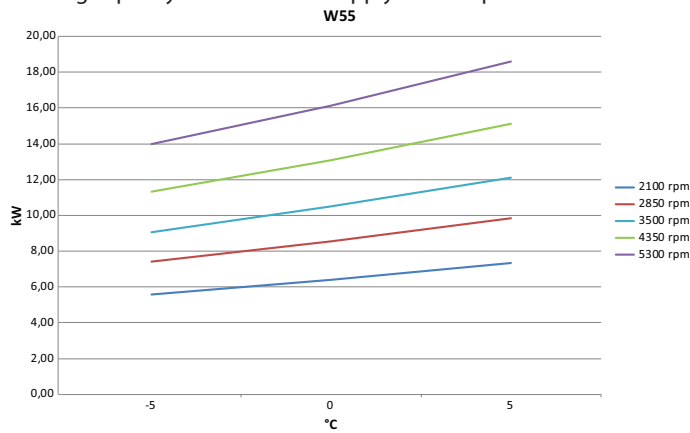

RPM	Brine temp.	-5	0	+5
2110	Heating capacity (kW)	5,6	6,4	7,3
	Input power (kW)	2,2	2,2	2,2
	COP	2,6	2,9	3,3
2850	Heating capacity (kW)	7,4	8,6	9,8
	Input power (kW)	2,8	2,8	2,9
	COP	2,7	3,0	3,4
3500	Heating capacity (kW)	9,1	10,5	12,1
	Input power (kW)	3,3	3,4	3,5
	COP	2,7	3,1	3,4
4350	Heating capacity (kW)	11,3	13,1	15,1
	Input power (kW)	4,2	4,3	4,5
	COP	2,7	3,0	3,4
5300	Heating capacity (kW)	14,0	16,1	18,6
	Input power (kW)	5,2	5,4	5,6
	COP	2,7	3,0	3,3



Technical description

Atlas & Calibra models

Serwis i Wsparcie: serwis@thermia.pl
Wsparcie Inwestycji i Projektów: projekty@thermia.pl
www.thermia.pl

Thermia can accept no responsibility for possible errors in catalogues, brochures and other printed material. Thermia reserves the right to alter its products without notice. This also applies to products already on order provided that such alterations can be made without subsequential changes being necessary in specifications already agreed. All trademarks in this material are property of the respective companies. Thermia AB and the Thermia AB logotype are trademarks of Thermia AB. All rights reserved.
